

The Big Brand Book

Aster

We'll Treat You Well



Foreword

Welcome to the Aster DM Healthcare Brand Guidelines. Here you can find all you need to keep in mind, while working on the various collaterals that represent our sub-brands and brand variants under the Group.

Why should brand guidelines be boring? We can take a joke, as long as it is on-brand. But, decoding the Aster brand can be quite a head-scratcher. Breathe! We got you! From talking the same language to staying color-coordinated, this book captures it all and much more.

Read on and we're sure you will get a fresh perspective.



**Branding 101:
Because 'Winging It'
Isn't a Superpower**



Contents

1. Aster DM Healthcare - Corporate Guidelines
2. Aster Hospital Guidelines
3. Aster Hospital Signage Guidelines
4. Aster Clinic Guidelines
5. Aster Pharmacy Guidelines
6. Aster Labs Guidelines
7. myAster Guidelines
8. Medicare Guidelines
9. Medicare Social Media Guidelines

Aster Corporate Brand Guidelines



Why do we need these guidelines anyway?



Ever seen a superhero without a costume? Yeah, neither have we.

CONTENTS

BRAND

Vision	01
Values	02
Mission	03
Promise	04

CORPORATE LOGO

Corporate Logo	05
Corporate Logo - Greyscale	06
Corporate Logo - Clear Space	07
Corporate Logo – Brand & Tagline Clear Space	08
Corporate Logo – Variations	09-10
Corporate Logo – Incorrect Usage	11

BRAND LANGUAGE

Colors	12
Typography - English	13
Typography - Malayalam	14
Typography – Marathi	15
Typography – Kannada	16
Typography – Telugu	17
Typography - Hindi	18
Typography – Arabic	19
Typography – English Web	20

CORPORATE STATIONERY & TEMPLATES

Business Card	21
Employee ID Card	22
Envelope A4 Collection	23
Envelope A5 Collection	24
Envelope DL Collection	25
Folder A4 Collection	26
Internal Documents	27
Letterhead Collection	28
Notepad	29
PPT Template	30

PRINT COMMS

Print AD Full Page	31
Print AD Half Page	32

SIGNAGE

Logo Stacked Tagline	33
Reception Signage	34

ACCESSORIES

Clock	35
-------	----

VEHICLE BRANDING

36

BRAND VISION

**Aster
Vision**



Dr. Azad Moopen,
MD, Founder Chairman,
Aster DM Healthcare

“**A Caring Mission with a Global Vision to serve the world with Accessible and Affordable Quality Healthcare.**”

BRAND VALUES

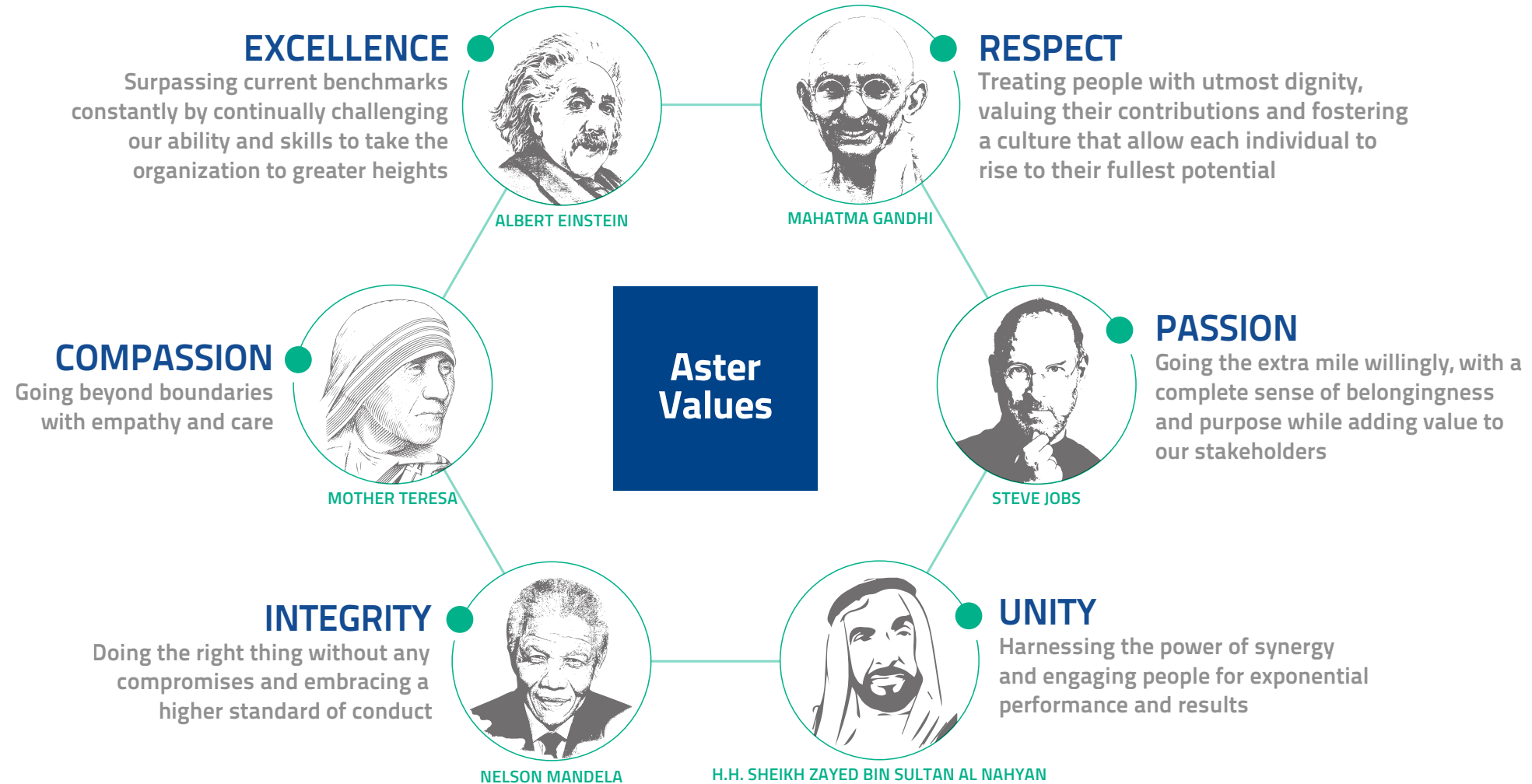

BRAND MISSION



People Excellence

Be among the Global Best Employers by 2030 where every Asterian finds purpose and aspires to be the best in providing care for our customers



Service Excellence

Establish Aster as one of the most trusted healthcare providers globally, through the creation of holistic healthcare experiences for 500 million patients by 2030 through their journey from illness to wellness



Clinical Excellence

While establishing several Global Centers of Clinical Excellence across the group, transform Aster Medcity, Kochi & Aster Hospitals, Bangalore to be the most recognized destinations for referral of patients from around the world by 2030



Technology, Digital Transformation & Innovation

Be one of the most technologically driven Healthcare companies to provide seamless omni-channel patient experience across the geographies through Innovation by adopting state of the art business models for Digital Transformation



Brand Equity

Be one among the globally recognized healthcare brands and the most preferred provider in markets that we operate through patient trust and ambassadorship



Sustainability & Community Connect

Build a sustainable future for Aster by defining a path that creates shared values benefitting the organization, community and the environment

Through community connect, be the leader in giving back to the societies we serve across the world by touching 1 million lives a year, with a network of 100,000 committed and passionate Aster Volunteers



Business Performance

Become one among the 5 most valued healthcare companies in the world with the growth strategy of 20 : 20 : 20 covering the core and non-core areas of healthcare, generating revenue of US \$ 7.5 billion with market cap of US \$ 20 billion by 2030

BRAND PROMISE

TAGLINE & TAGLINE USAGE

We'll Treat You Well



CORPORATE LOGO



CORPORATE LOGO

GREYSCALE



■ CMYK
C 0 / M 0 / Y 0 / K 80

■ RGB
R 88 / G 89 / B 91

■ CMYK
C 0 / M 0 / Y 0 / K 60

■ RGB
R 128 / G 130 / B 133

■ CMYK
C 0 / M 0 / Y 0 / K 50

■ RGB
R 147 / G 149 / B 152

CORPORATE LOGO

CLEAR SPACE

GRID GUIDELINE 1



GRID GUIDELINE 2

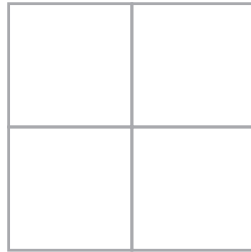

GRID GUIDELINE 3



CORPORATE LOGO

BRAND & TAGLINE CLEAR SPACE

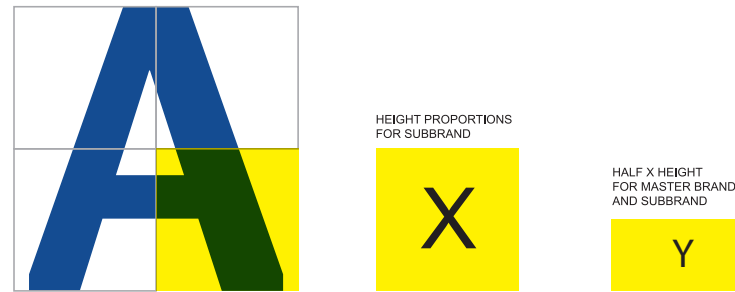

CORPORATE LOGO VARIATIONS

Aster
We'll Treat You Well



Aster
PRIME HOSPITAL
We'll Treat You Well

Aster
AADHAR HOSPITAL
We'll Treat You Well

Aster
RV HOSPITAL
We'll Treat You Well

Aster
CMI HOSPITAL
We'll Treat You Well

Aster
WOMEN & CHILDREN
We'll Treat You Well

Aster
MIMS HOSPITAL
We'll Treat You Well

Aster
MOTHER HOSPITAL
We'll Treat You Well

AsterMedcity
We'll Treat You Well™

Aster
HOSPITAL
We'll Treat You Well

Aster
CEDARS HOSPITAL
We'll Treat You Well

Aster
SANAD HOSPITAL
We'll Treat You Well

Aster
AL RAFFAH HOSPITAL
We'll Treat You Well

CORPORATE LOGO VARIATIONS

Aster
We'll Treat You Well



Aster
CLINIC
We'll Treat You Well

Aster
DIAGNOSTIC CENTRE
We'll Treat You Well

Aster
DAY SURGERY CENTRE
We'll Treat You Well

AO Aster
OPTICALS
A TREAT FOR YOUR EYES

Aster  **Online**.com

Aster
GP CLINIC
We'll Treat You Well

Aster
CEDARS CLINIC
We'll Treat You Well

Aster
MEDICAL IMAGING
We'll Treat You Well

Aster LABS
We'll Treat You Well

Aster
PHARMACY
We'll Treat You Well





myAster
My Health In My Hands

CORPORATE LOGO INCORRECT USAGE

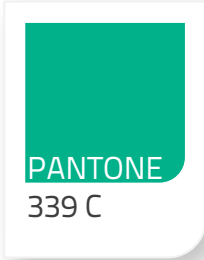

- Do not change the proportions of the elements within the logo.
- Do not change the colour order.
- Do not put a stroke around any element of the logo.
- Do not change the orientation of the logo.
- Do not alter the logotype or use an alternate typeface.
- Do not crop the mark.
- Do not blend any other corporate name, text or logo.

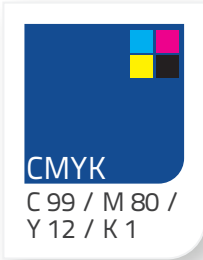
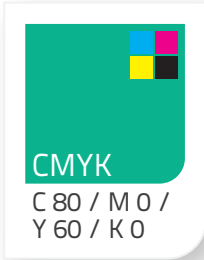
CORPORATE BRAND COLORS

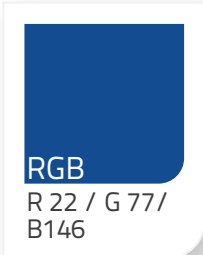
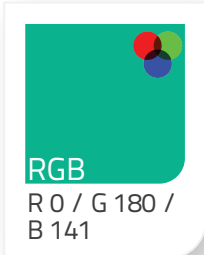
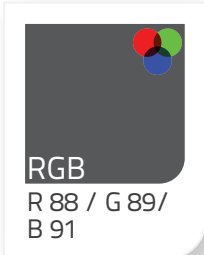
	COLOR	SECONDARY COLOR	SECONDARY COLOR
PANTONE	 <p>PANTONE 7687 C</p>	 <p>PANTONE 339 C</p>	 <p>PANTONE 425 C</p>
C M Y K	 <p>CMYK C 99 / M 80 / Y 12 / K 1</p>	 <p>CMYK C 80 / M 0 / Y 60 / K 0</p>	 <p>CMYK C 0 / M 0 / Y 0 / K 80</p>
WEB/DIGITAL	 <p>RGB R 22 / G 77 / B 146</p>	 <p>RGB R 0 / G 180 / B 141</p>	 <p>RGB R 88 / G 89 / B 91</p>

CORPORATE TYPOGRAPHY

ENGLISH

TitillumText22L Thin

ABCDEFGHIJKLMNOPQRSTUVWXYZ
abcdefghijklmnopqrstuvwxyz

TitillumText22L Regular

ABCDEFGHIJKLMNOPQRSTUVWXYZ
abcdefghijklmnopqrstuvwxyz

TitillumText22L Bold

ABCDEFGHIJKLMNOPQRSTUVWXYZ
abcdefghijklmnopqrstuvwxyz

TitillumText22L XBold

ABCDEFGHIJKLMNOPQRSTUVWXYZ
abcdefghijklmnopqrstuvwxyz

CORPORATE TYPOGRAPHY

MALAYALAM

Baloo Chettan 2 Regular

അആഇഇഊഉഘൃണൃഷൃഌഎ഑
ഔകഖഘങചഛജടഡണടഡ

Baloo Chettan 2 SemiBold

അആഇഇഊഉഘൃണൃഷൃഌഎ഑
ഔകഖഘങചഛജടഡണടഡ

Baloo Chettan 2 ExtraBold

അആഇഇഊഉഘൃണൃഷൃഌഎ഑
ഔകഖഘങചഛജടഡണടഡ

Baloo Chettan 2 Medium

അആഇഇഊഉഘൃണൃഷൃഌഎ഑
ഔകഖഘങചഛജടഡണടഡ

Baloo Chettan 2 Bold

അആഇഇഊഉഘൃണൃഷൃഌഎ഑
ഔകഖഘങചഛജടഡണടഡ

CORPORATE TYPOGRAPHY

MARATHI

Baloo 2 Regular

अआइईउऊऋलृँऐएऐऑओऔकखगघडच
छजझञटठडढणतथदधननपफबभमयररलळ

Baloo 2 SemiBold

अआइईउऊऋलृँऐएऐऑओऔकखगघडच
छजझञटठडढणतथदधननपफबभमयररलळ

Baloo 2 ExtraBold

अआइईउऊऋलृँऐएऐऑओऔकखगघडच
छजझञटठडढणतथदधननपफबभमयररलळ

Baloo 2 Medium

अआइईउऊऋलृँऐएऐऑओऔकखगघडच
छजझञटठडढणतथदधननपफबभमयररलळ

Baloo 2 Bold

अआइईउऊऋलृँऐएऐऑओऔकखगघडच
छजझञटठडढणतथदधननपफबभमयररलळ

CORPORATE TYPOGRAPHY

KANNADA

Baloo Tamma 2 Regular

ಅಆಇಈಉಊಠಮೃಌವಠಒಓಔಐ
ಕಖಗಘಙಚಛಠಜಝಞಟಠಡಢತಥ

Baloo Tamma 2 SemiBold

ಅಆಇಈಉಊಠಮೃಌವಠಒಓಔಐ
ಕಖಗಘಙಚಛಠಜಝಞಟಠಡಢತಥ

Baloo Tamma 2 ExtraBold

ಅಆಇಈಉಊಠಮೃಌವಠಒಓಔಐ
ಕಖಗಘಙಚಛಠಜಝಞಟಠಡಢತಥ

Baloo Tamma 2 Medium

ಅಆಇಈಉಊಠಮೃಌವಠಒಓಔಐ
ಕಖಗಘಙಚಛಠಜಝಞಟಠಡಢತಥ

Baloo Tamma 2 Bold

ಅಆಇಈಉಊಠಮೃಌವಠಒಓಔಐ
ಕಖಗಘಙಚಛಠಜಝಞಟಠಡಢತಥ

CORPORATE TYPOGRAPHY

TELUGU

Baloo Tammudu 2 Regular

అఆఇఈఉఊఋౠఎవ్ఐఒఓఔకఖ
గఘజచఛజఝఞటఠడఢణతథదధ

Baloo Tammudu 2 SemiBold

అఆఇఈఉఊఋౠఎవ్ఐఒఓఔకఖ
గఘజచఛజఝఞటఠడఢణతథదధ

Baloo Tammudu 2 ExtraBold

అఆఇఈఉఊఋౠఎవ్ఐఒఓఔకఖ
గఘజచఛజఝఞటఠడఢణతథదధ

Baloo Tammudu 2 Medium

అఆఇఈఉఊఋౠఎవ్ఐఒఓఔకఖ
గఘజచఛజఝఞటఠడఢణతథదధ

Baloo Tammudu 2 Bold

అఆఇఈఉఊఋౠఎవ్ఐఒఓఔకఖ
గఘజచఛజఝఞటఠడఢణతథదధ

CORPORATE TYPOGRAPHY

HINDI

Baloo 2 Regular

अआइईउऊऋऌएँऐऑओऔकखगघङचछज
झञटठडढणतथदधनपफबभमयररलळवशष

Baloo 2 SemiBold

अआइईउऊऋऌएँऐऑओऔकखगघङचछज
झञटठडढणतथदधनपफबभमयररलळवशष

Baloo 2 ExtraBold

अआइईउऊऋऌएँऐऑओऔकखगघङचछज
झञटठडढणतथदधनपफबभमयररलळवशष

Baloo 2 Medium

अआइईउऊऋऌएँऐऑओऔकखगघङचछज
झञटठडढणतथदधनपफबभमयररलळवशष

Baloo 2 Bold

अआइईउऊऋऌएँऐऑओऔकखगघङचछज
झञटठडढणतथदधनपफबभमयररलळवशष

CORPORATE TYPOGRAPHY

ARABIC

GE Dinar One - Light

ا ب ت ث ج ح خ د ذ ر ز س ش ص ض ط ظ ع غ ف ق ك ل م ن ه و ي

GE Dinar One - Light Italic

ا ب ت ث ج ح خ د ذ ر ز س ش ص ض ط ظ ع غ ف ق ك ل م ن ه و ي

GE Dinar One - Regular

ا ب ت ث ج ح خ د ذ ر ز س ش ص ض ط ظ ع غ ف ق ك ل م ن ه و ي

GE Dinar One - Medium

ا ب ت ث ج ح خ د ذ ر ز س ش ص ض ط ظ ع غ ف ق ك ل م ن ه و ي

GE Dinar One - Medium Italic

ا ب ت ث ج ح خ د ذ ر ز س ش ص ض ط ظ ع غ ف ق ك ل م ن ه و ي

GE Dinar One - Bold

ا ب ت ث ج ح خ د ذ ر ز س ش ص ض ط ظ ع غ ف ق ك ل م ن ه و ي

GE Dinar One - Black

ا ب ت ث ج ح خ د ذ ر ز س ش ص ض ط ظ ع غ ف ق ك ل م ن ه و ي

CORPORATE TYPOGRAPHY

ENGLISH - WEB

TitillumText22L Thin

ABCDEFGHIJKLMNOPQRSTUVWXYZ
abcdefghijklmnopqrstuvwxyz

TitillumText22L Regular

ABCDEFGHIJKLMNOPQRSTUVWXYZ
abcdefghijklmnopqrstuvwxyz

TitillumText22L Bold

ABCDEFGHIJKLMNOPQRSTUVWXYZ
abcdefghijklmnopqrstuvwxyz

Stag Sans Light

ABCDEFGHIJKLMNOPQRSTUVWXYZ
abcdefghijklmnopqrstuvwxyz

Stag Sans Book

ABCDEFGHIJKLMNOPQRSTUVWXYZ
abcdefghijklmnopqrstuvwxyz

Stag Sans Medium

ABCDEFGHIJKLMNOPQRSTUVWXYZ
abcdefghijklmnopqrstuvwxyz

CORPORATE STATIONERY BUSINESS CARD

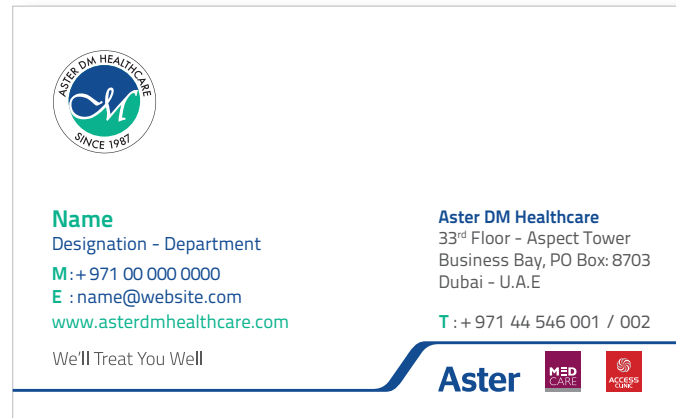

Size: 90 x 50 mm

Paper: 300 GSM linen half white texture board

CORPORATE STATIONERY

EMPLOYEE ID CARD



The image displays a template for an Aster DM Healthcare Employee ID Card. The card is divided into two main sections: a front side (left) and a back side (right).

Front Side (Left):

- Header:** Aster logo with tagline "We'll Treat You Well" and the Aster DM Healthcare logo (a green circle with a white 'M' and "SINCE 1987").
- Photo:** A grey silhouette placeholder for the employee's photo.
- Text:** "Your Name" and "Department Name" in a large, bold font.
- QR Code:** A square QR code.
- Contact Info:** "ID: 2938470 | Mob. 000 000 0000".
- Footer:** "www.asterdmhealthcare.com".

Back Side (Right):

- Header:** "Aster Vision" in green.
- Mission Statement:** "A Caring Mission with a Global Vision to serve the world with Accessible and Affordable Quality Healthcare".
- Fields:** "Position", "DOJ : DD/MM/YYYY", "DOB : DD/MM/YYYY", "Blood Group:", "Emergency Number", and "+ 00 00 00000".
- INSTRUCTIONS:**
 1. The card should always be displayed by the holder while on duty
 2. This card must be produced on demand to the Security Staff or any authorised officer
 3. Loss or found of card should be reported to Administrative Dept. immediately.
- Footer:** "Aster DM Healthcare" and contact details: "Al Hudaiba Awards Buildings, 3rd Floor, Block A, Jumeirah Road, 2nd December Interchange, Dubai, UAE, Tel. Number : + 971 4 454 6001".
- Bottom Bar:** "We'll Treat You Well".

CORPORATE STATIONERY ENVELOPE A4 COLLECTION

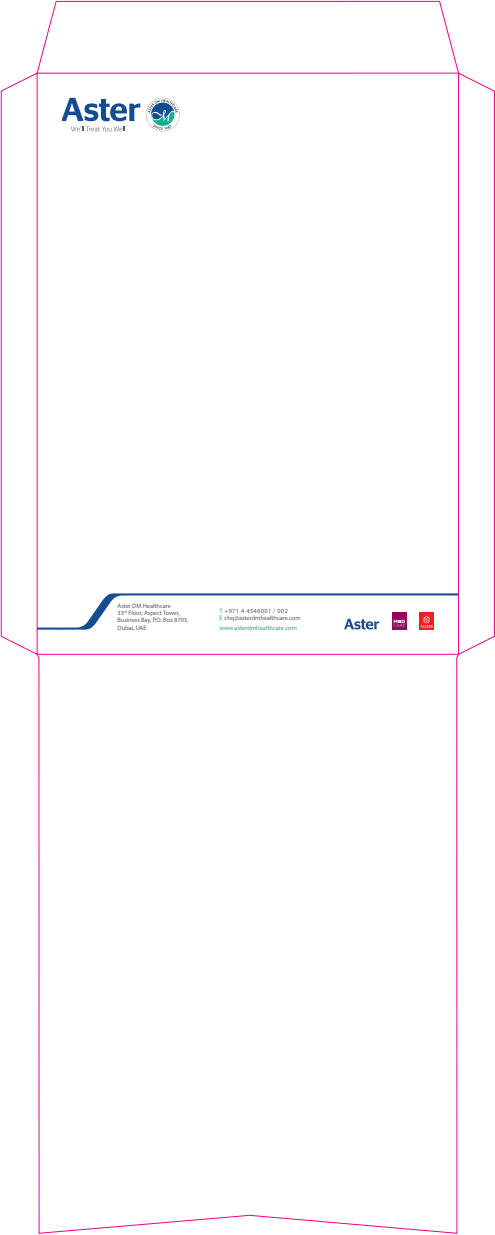

Envelope A4 Size
32.4cm X 23.5cm

CORPORATE STATIONERY ENVELOPE A5 COLLECTION

Envelope A5 Size
22cm X 15.85 cm



CORPORATE STATIONERY

ENVELOPE DL COLLECTION

Envelope - Corporate
DL Size 22cm X 11cm



CORPORATE STATIONERY

FOLDER A4 COLLECTION

Back



Front



Inside

Care is Just an Aster Away was a campaign line used specifically for UAE during Expo 2020 campaign to denote the scale of our network. The actual creative for the campaign listed the business facilities number – x hospitals, x clinics, x pharmacies and read as – With the largest healthcare network in UAE, Care is Just an Aster Away. The campaign line clicked well, and we had continued to use the shortened line in geographies with large presence. As of 2023, we have started phasing out this campaign line from new communication collaterals. Leaving this .note here for reference and context. New artwork will be uploaded in next round

CORPORATE STATIONERY

INTERNAL DOCUMENTS

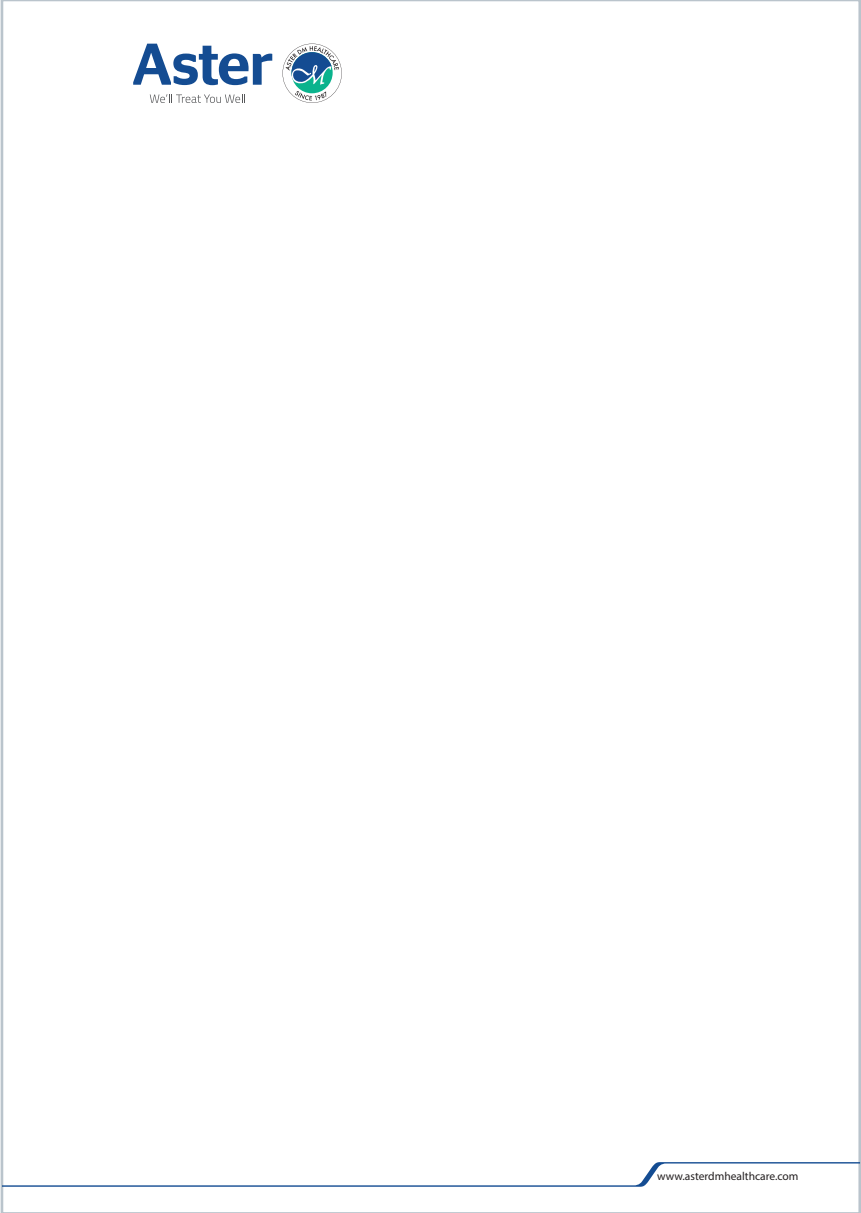

CORPORATE STATIONERY

LETTERHEAD COLLECTION

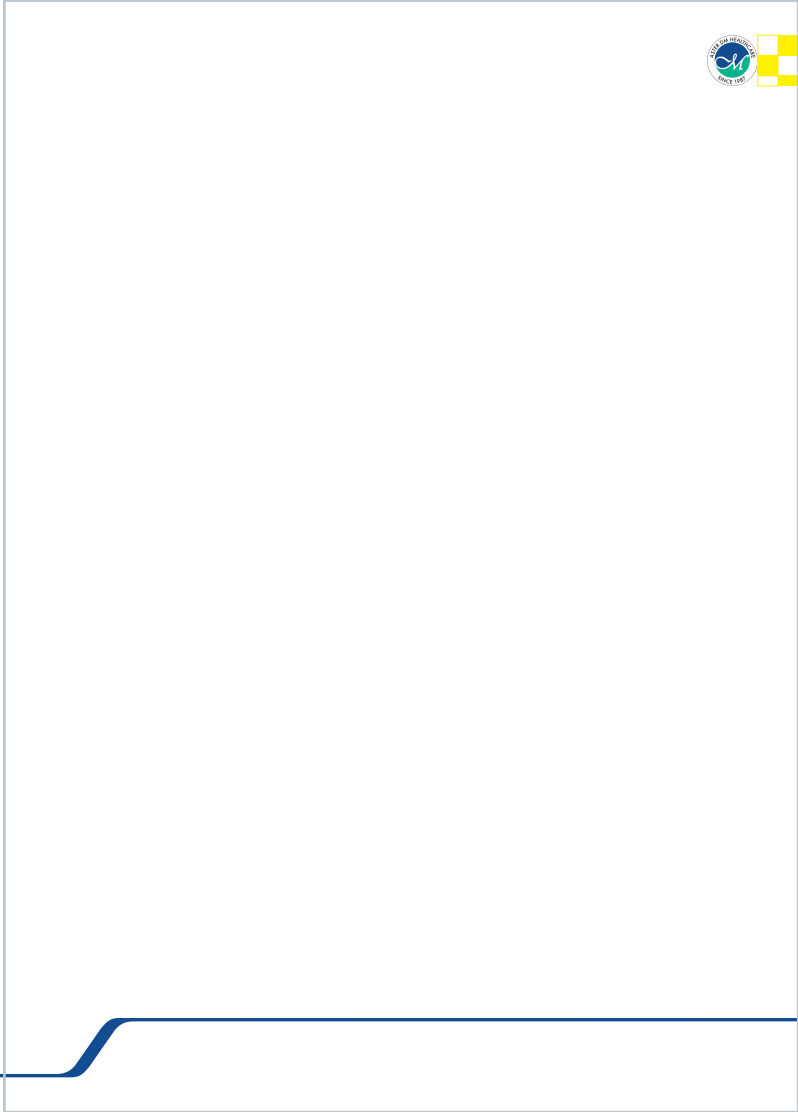
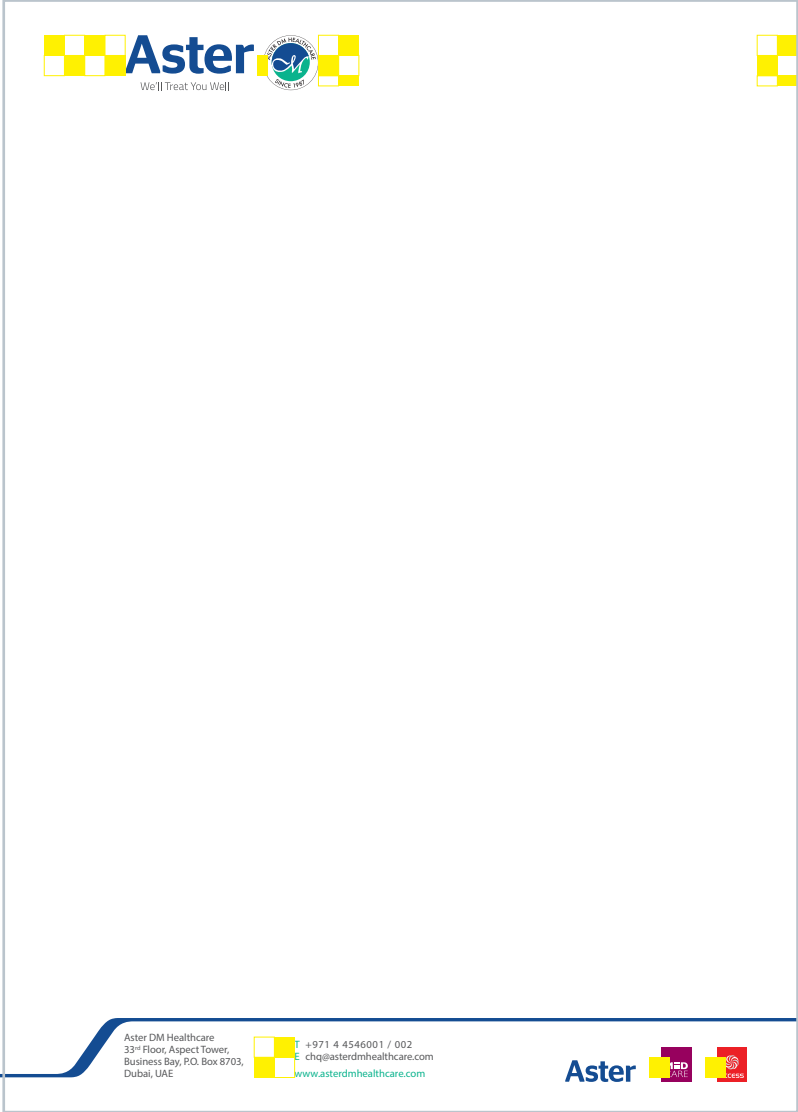

CORPORATE STATIONERY

NOTEPAD



Front

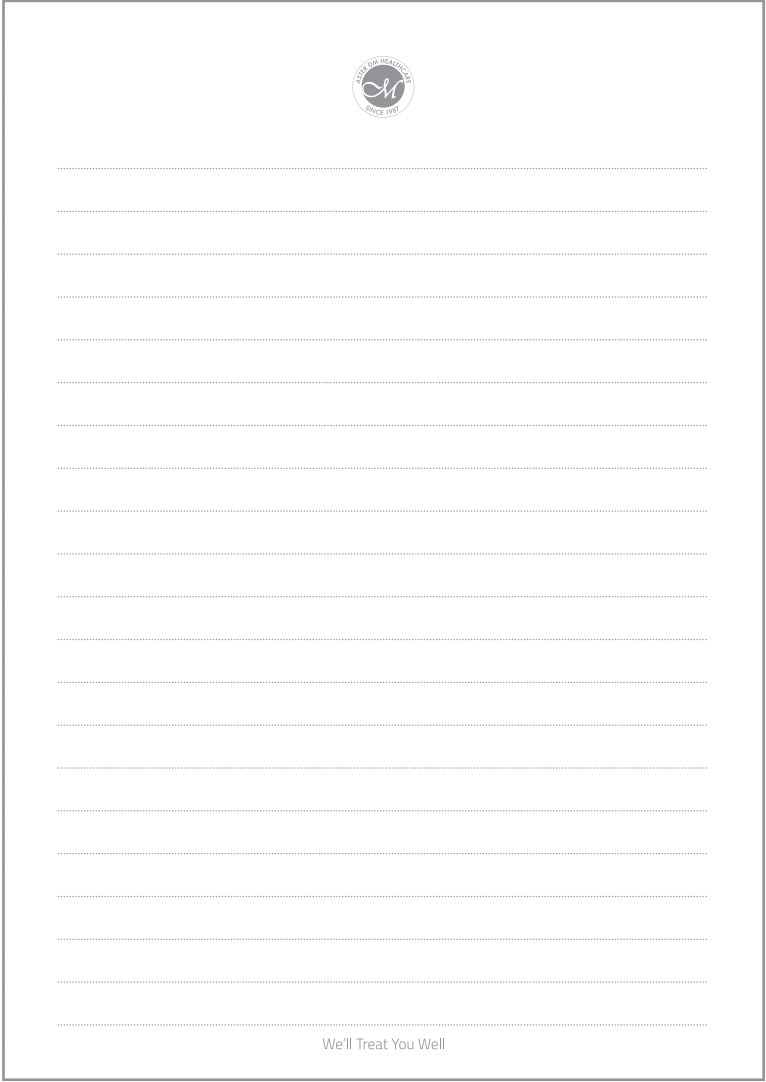

Inside

CORPORATE STATIONERY

PPT TEMPLATE



Aster DM Healthcare

DATE





Thank You

PRINT COMMS

PRINT AD - FULL PAGE



Lorem ipsum dolor sit amet, consectetur adipiscing elit, sed diam nonummy nibh euismod tincidunt ut laoreet dolore magna aliquam erat volutpat. Ut wisi enim ad minim veniam, quis nostrud exerci tation ullamcorper suscipit lobortis nisl ut aliquip ex ea commodo consequat. Duis autem vel eum iriure dolor in hendrerit in vulputate velit esse molestie consequat, vel illum dolore eu feugiat nulla facilisis at vero eros et accumsan et iusto odio dignissim qui blandit praesent luptatum zzril delenit augue dui erat Lorem ipsum dolor sit amet, consectetur adipiscing elit, sed diam nonummyaesent luptatumaesent luptatum lore magna



— We'll Treat You Well —

7 Countries | 455 Facilities | 27 Hospitals | 126 Clinics/Labs | 302 Pharmacies | www.asterdmhealthcare.com

PRINT COMMS

PRINT AD - HALF PAGE



Lorem ipsum dolor sit amet, consectetur adipiscing elit, sed diam nonummy nibh euismod tincidunt ut laoreet dolore magna aliquam erat volutpat. Ut wisi enim ad minim veniam, quis nostrud exerci tation ullamcorper suscipit lobortis nisl ut aliquip ex ea commodo consequat. Duis autem vel eum iriure dolor in hendrerit in vulputate velit esse molestie consequat, vel illum dolore eu feugiat nulla facilisis at vero eros et accumsan et iusto odio dignissim qui blandit praesent luptatum zzril delenit augue duis erat Lorem ipsum dolor sit amet, consectetur adipiscing elit, sed diam nonummyaesent luptatumaesent luptatum lore magna



7 Countries | 455 Facilities | 27 Hospitals | 126 Clinics/Labs | 302 Pharmacies | www.asterdhealthcare.com

SIGNAGE

LOGO STACKED TAGLINE

Aster

We'll Treat You Well



SIGNAGE

RECEPTION SIGNAGE



Aster



————— We'll Treat You Well —————

ACCESSORIES

CLOCK



VEHICLE BRANDING



THANK YOU

Aster Hospital Brand Guidelines

Why did the brand guidelines start a cooking show?

They had the recipe for brand success!



CONTENTS

ASTER HOSPITAL - LOGO

Aster Hospital Logo	31
Aster Hospital Stacked Logo - Clear Space	32
Aster Hospital Stacked Logo - Variations	33
Aster Hospital Stacked Logo - Minimum Size	34
Aster Hospital Tagline Usage	35
Aster Hospital Extended Logo	36
Aster Hospital Extended Logo - Variations	37
Aster Hospital Extended Logo - Minimum Size	38
Aster Hospital Extended Logo - Clear Space	39
Aster Hospital Logo - Reverse	40
Aster Hospital Logo - Incorrect Usage	41

ASTER HOSPITAL - STATIONERY & TEMPLATES

Business Card	42
A4 Letterhead	43
A4 Envelope	44
A5 Envelope	45
DL Envelope	46
Folder	47
A5 Notepad	48
CD Label & Cover	49
Patient Leaflet	50
ID Card	51
MRI/CT Scan Scan Carry Bag	52
Medicine Cover	53
Forms	54
Visitor Pass	55
Parking Sticker	56
Powerpoint Template	57
E-mail Signature Template	58
Backdrop	59

ASTER HOSPITAL PRINT COMMUNICATION

Vertical Ad	60
Horizontal Ad	61

ASTER HOSPITAL - OUTDOOR COMMUNICATION

Vertical Billboard	62
Horizontal Billboard	63

ASTER HOSPITAL SIGNAGES

Extended Logo	64
Stacked Logo	65

ASTER HOSPITAL AMBULANCE BRANDING

Ambulance	66
-----------	----

ASTER HOSPITAL ACCESSORIES

Wall Clock	67
------------	----

ASTER HOSPITAL - BED LINEN & CURTAINS

Bed Linen, Pillow Cover & Blanket	68
Bedside Curtains	69
Window - Blackout Blinds	70
Window - Curtains	71

ASTER HOSPITAL UNIFORMS - INDIA

Doctor's Coat/ Apron	72
Doctor's Scrub	73
Nurses - Male & Female	74
Nurses Aid	75
Customer Relations – Male	76
Customer Relations – Female	77
Pharmacy / Technicians	78
Maternity Wear	79
Security	80
Name Tag	81
Badge	82
Shoes	83

ASTER HOSPITAL UNIFORMS - GCC

Doctor's Apron	84
Male & Female Nurse	85
Male & Female Nurse Officer	86
Female Nurse Manager	87
Male Nurse Manager	88
OT Scrub Suit	89
NICU Scrub Suit	90
ICU Scrub Suit	91
ER Scrub Suit	92
Labour Room Scrub Suit	93
General/ Well Baby Scrub Suit	94
Support Staff	95
Office Staff	96

ASTER HOSPITAL - LOGO

Aster Hospital Logo	31
Aster Hospital Stacked Logo - Clear Space	32
Aster Hospital Stacked Logo - Variations	33
Aster Hospital Stacked Logo - Minimum Size	34
Aster Hospital Tagline Usage	35
Aster Hospital Extended Logo	36
Aster Hospital Extended Logo - Variations	37
Aster Hospital Extended Logo - Minimum Size	38
Aster Hospital Extended Logo - Clear Space	39
Aster Hospital Logo - Reverse	40
Aster Hospital Logo - Incorrect Usage	41

ASTER HOSPITAL LOGO



ASTER HOSPITAL STACKED LOGO

CLEAR SPACE

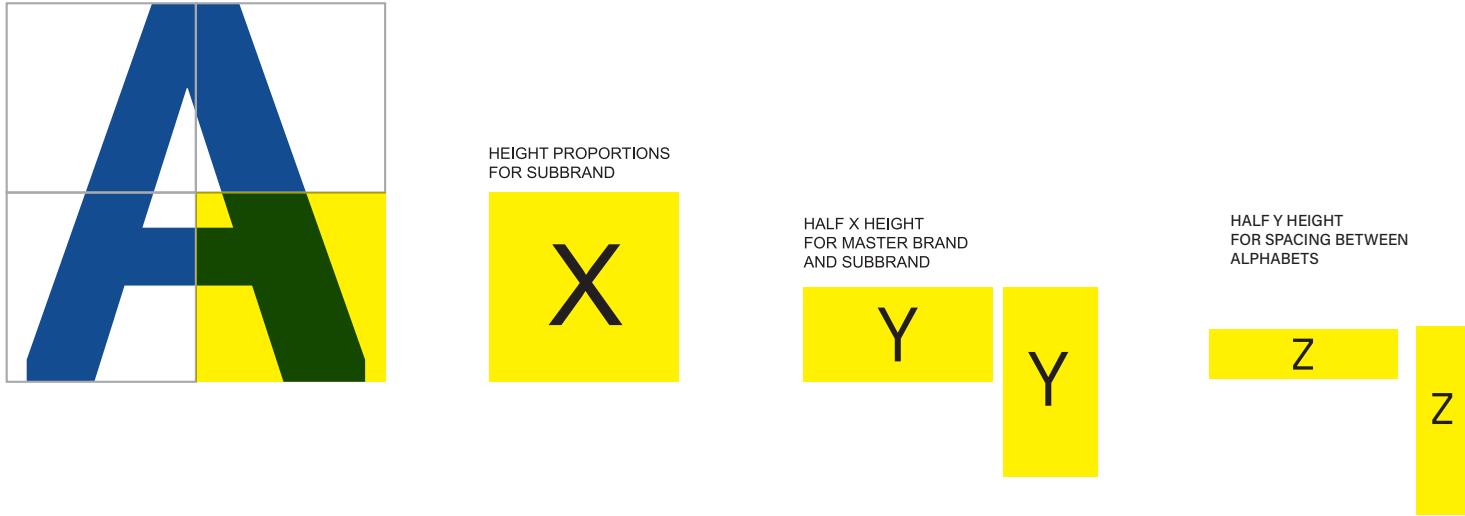

ASTER HOSPITAL STACKED LOGO VARIATIONS



HEIGHT PROPORTIONS FOR SUBBRAND



HALF X HEIGHT FOR MASTER BRAND AND SUBBRAND



HALF Y HEIGHT FOR SPACING BETWEEN ALPHABETS

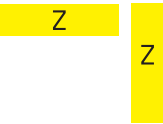

ASTER HOSPITAL STACKED LOGO
MINIMUM SIZE



ASTER HOSPITAL LOGO

TAGLINE USAGE

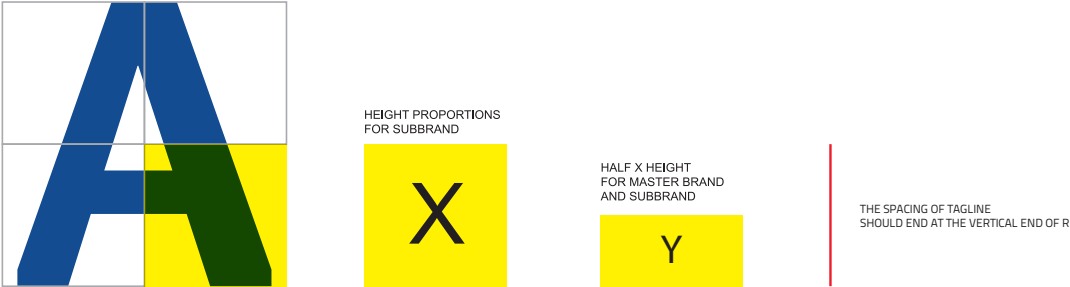

Aster
HOSPITAL
We'll Treat You Well

The logo is displayed with the tagline. The word 'Aster' is in blue, 'HOSPITAL' is in green, and the tagline 'We'll Treat You Well' is in grey. Two yellow boxes with the letter 'Y' are positioned to the left of the 'HOSPITAL' text, indicating the height of the tagline. A vertical red line is positioned to the right of the tagline, indicating the end of the tagline spacing.

ASTER HOSPITAL LOGO
EXTENDED

Aster HOSPITAL

ASTER HOSPITAL EXTENDED LOGO VARIATIONS

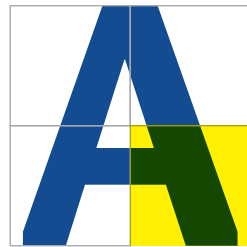

HEIGHT PROPORTIONS FOR SUBBRAND



HALF X HEIGHT FOR MASTER BRAND AND SUBBRAND



HALF Y HEIGHT FOR SPACING BETWEEN ALPHABETS

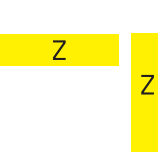

Aster PRIME HOSPITAL

Aster AIADHAR HOSPITAL

Aster MIMS HOSPITAL

Aster WOMEN & CHILDREN

Aster CMI HOSPITAL

Aster RIV HOSPITAL

Aster WHITEFIELD HOSPITAL

Aster MOTHER HOSPITAL

ASTER HOSPITAL EXTENDED LOGO

MINIMUM SIZE



ASTER HOSPITAL EXTENDED LOGO

CLEAR SPACE

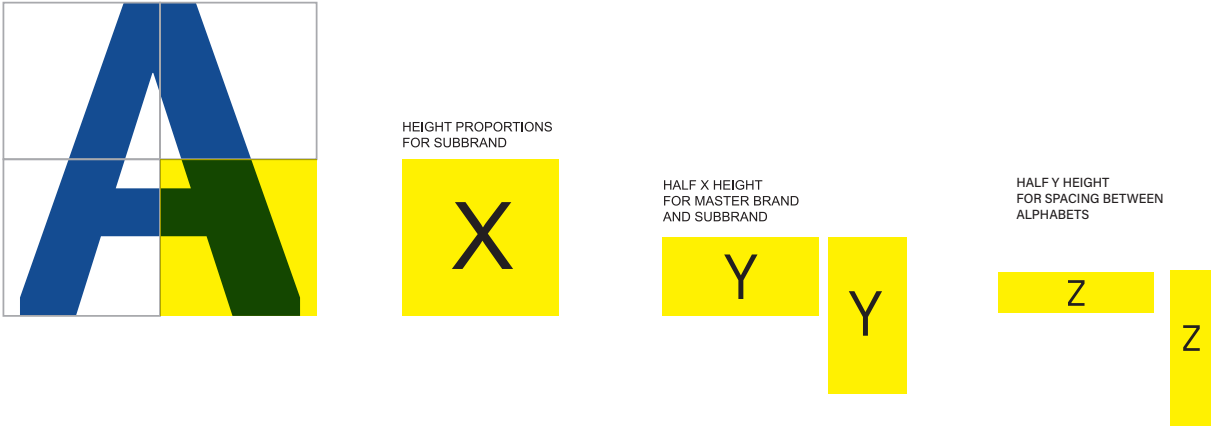

ASTER HOSITAL LOGO

REVERSE



Stacked Logo – Full Colour



Stacked Logo – Single Colour



Stacked Logo – Single Colour Reverse



Extended Logo – Full Colour



Extended Logo – Single Colour



Extended Logo – Single Colour Reverse

ASTER HOSPITAL LOGO INCORRECT USAGE



- Do not change the proportions of the elements within the logo.
- Do not change the colour order.
- Do not put a stroke around any element of the logo.
- Do not change the orientation of the logo.
- Do not alter the logotype or use an alternate typeface.
- Do not crop the mark.
- Do not blend any other corporate name, text or logo with the Aster Hospital logo.
- Do not use the tagline with the extended logo.
- Do not use the tagline with the stacked logo if it is below 12 mm.

ASTER HOSPITAL - STATIONERY & TEMPLATES

Business Card	42	MRI/CT Scan Scan Carry Bag	52
A4 Letterhead	43	Medicine Cover	53
A4 Envelope	44	Forms	54
A5 Envelope	45	Visitor Pass	55
DL Envelope	46	Parking Sticker	56
Folder	47	Powerpoint Template	57
A5 Notepad	48	E-mail Signature Template	58
CD Label & Cover	49	Backdrop	59
Patient Leaflet	50		
ID Card	51		

STATIONERY BUSINESS CARD



Size: 90 x 54 mm

Paper: 300 GSM linen half white texture board

STATIONERY

A4 LETTERHEAD

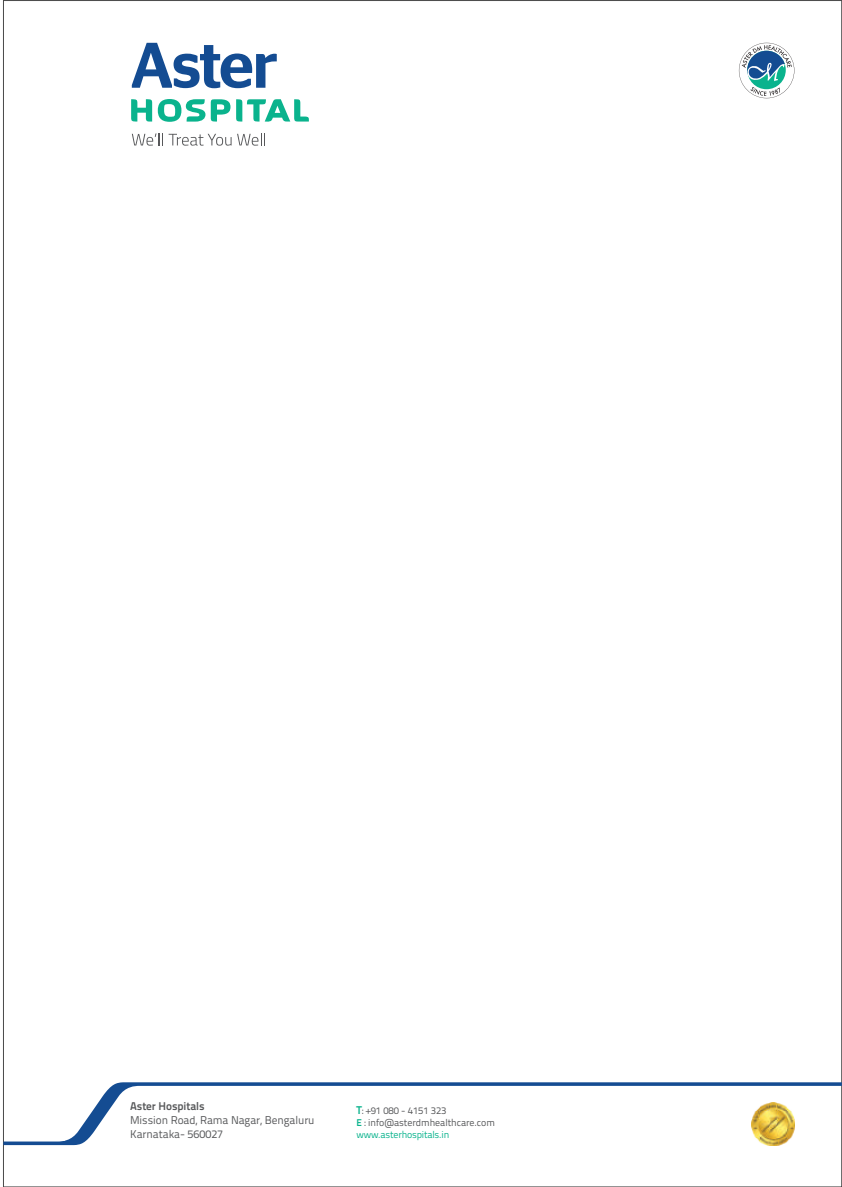

Size: A4
Paper: 120 GSM maplitho

STATIONERY

A4 ENVELOPE

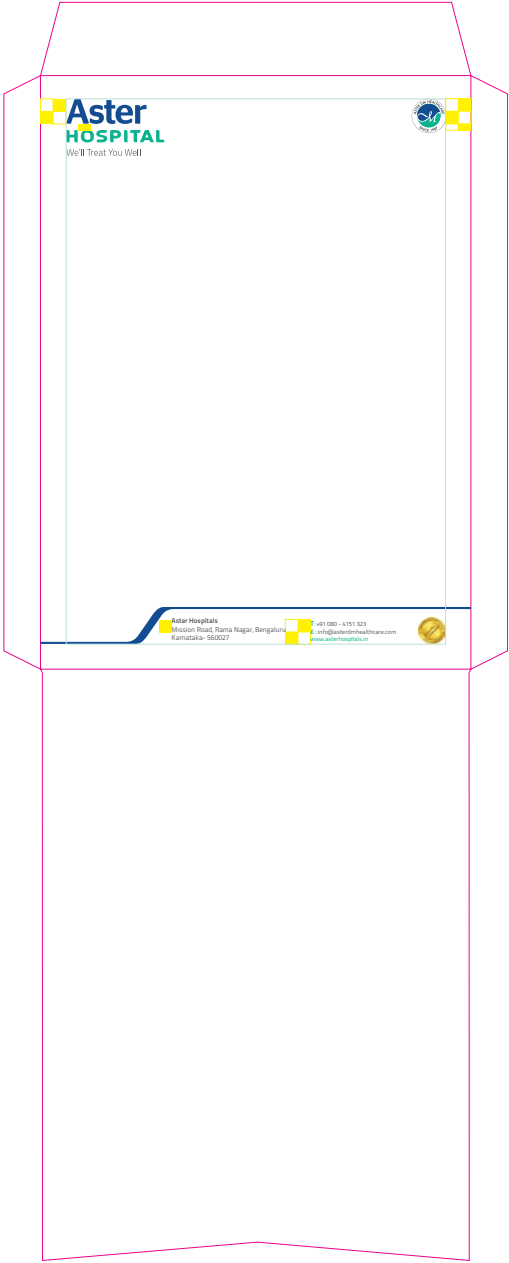

Size: A4 (Open Size: 32.4cm X 23.5cm)
Paper: 120 GSM maplitho

STATIONERY

A5 ENVELOPE



Size: A5 (Open Size: 22cm X 15.85cm)
Paper: 120 GSM maplitho

STATIONERY DL ENVELOPE



Size: 22cm X 11cm
Paper: 120 GSM maplitho

STATIONERY FOLDER

32cm x 48cm

Front



Open



Back



Pouch

Size: (W) 48cm x (H) 32cm,
Paper: 300 GSM matte lamination on top inner double pouch & CD cover

STATIONERY

A5 NOTEPAD

Cover



Inside page

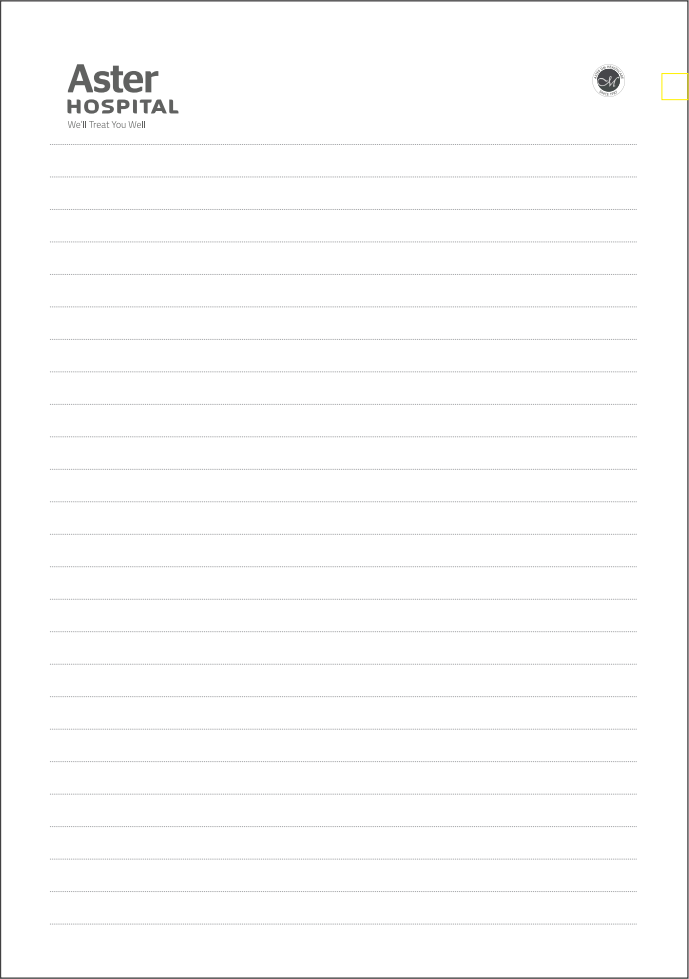

Size: A5 Size
Paper : Cover - 130 GSM art, inner pages - 90 GSM maplitho

STATIONERY

CD LABEL & COVER



Size: 11.8cm X 11.8cm (CD Cover)
Paper: CD Pouch - 300 GSM matte lamination, CD - Sticker

STATIONERY PATIENT LEAFLET



ANAESTHESIA WHAT YOU SHOULD KNOW AND WHAT TO EXPECT

PLEASE SCAN FOR DIGITAL VERSION

Aster HOSPITAL
We'll Treat You Well

@ asterhospitals.in



• If you ever require to undergo a surgery or an interventional procedure for a medical condition, you will be administered Anaesthesia: a situation to ensure that you will neither feel the pain nor be aware of the painful surgical procedure.

• Anaesthesia is always administered by a qualified Anaesthesiologist - an expert at making you sleep and pain free during the procedure while making sure that you are in the best possible physiological (health) status and then bringing you back to consciousness smoothly. Like a Dream!!

• Anaesthesia can be given in different ways, depending on your present health status and the surgery / procedure. Your Anaesthesiologist will advise you on the best mode of Anaesthesia after a thorough assessment of your health condition.

UNDERSTANDING ANAESTHESIOLOGIST

• We are trained (medical) professionals who take care of you when you are in surgery. In the operating room, your anaesthesiologist takes on the role of cardiologist, pulmonologist, physician and pain manager. That is why we call ourselves your "perioperative physician". We are a "JACK OF ALL TRADES". In the operating room we are your best friends with nothing more than your interest at heart. Once your surgeon decides and fixes a date for surgery, you will have a consultation with us. We will discuss with you the best options of anaesthesia based on the surgical procedure and your health status.

UNDERSTANDING PRE-ANAESTHETIC CHECK-UP

• The Pre-Anaesthetic Check-Up session (PAC) is a meeting wherein the Anaesthesiologist will discuss with you in detail about your present /past medical conditions and he/she will assess and evaluate whether you are fit and healthy enough to undergo the procedure. The surgery / medical procedure will not be performed until the Anaesthesiologist gives a go-ahead. Therefore, it's very important that you inform him/her about your:

- Complete medical history
- Previous illnesses, surgeries and procedures if any
- Medications you are taking / were taking- Allergies / drug allergies
- Personal habits, including drinking and smoking
- Family history of illnesses

• This will help your Anaesthesiologist decide the best type of Anaesthesia for you and ascertain the level of medications required, based on your health status. Remember, not disclosing relevant information can pose a huge risk to your life during the surgery / procedure and post-operative care. Also, PAC will help your Anaesthesiologist decide whether you require a consultation with any other speciality before surgery. This is to make sure that you are in the most optimum state of health before you come for surgery.

• You will be seen by the anaesthesiologist before the day of the surgery and he/she will give advice on your dietary regulations during the perioperative period. He/she will also brief you on the plan for anaesthesia and what is to be expected when you arrive in the operating room (OR), so that when you come to the OR every step will be familiar to you.

• Your consent as well as your relative's / family member's consent for administering Anaesthesia during the procedure will be taken.

TYPES OF ANAESTHESIA

• There are different ways of giving anaesthesia which includes General Anaesthesia that makes the patient sedated and paralysed and Local Anaesthesia that numbs only a part of the body.

GENERAL ANAESTHESIA

• General Anaesthesia is a type of

Size: A5 Size
Paper: 130 GSM art

STATIONERY ID CARD

Front

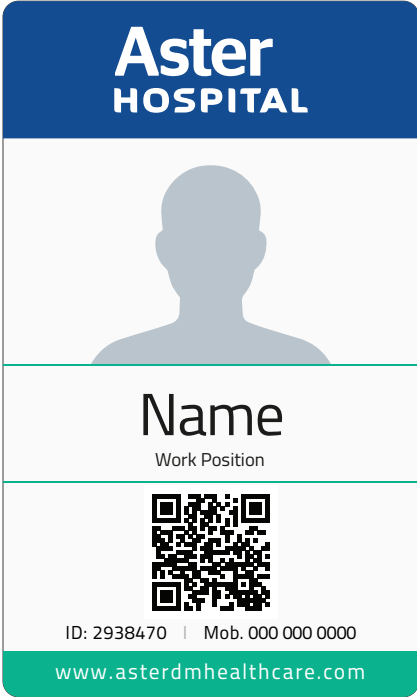

Back

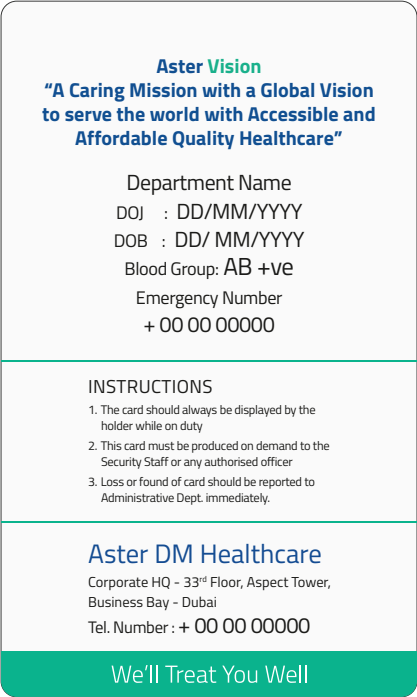

Size: 3.375" x 2.125"
Material: PVC

STATIONERY

MRI/CT SCAN CARRY BAG

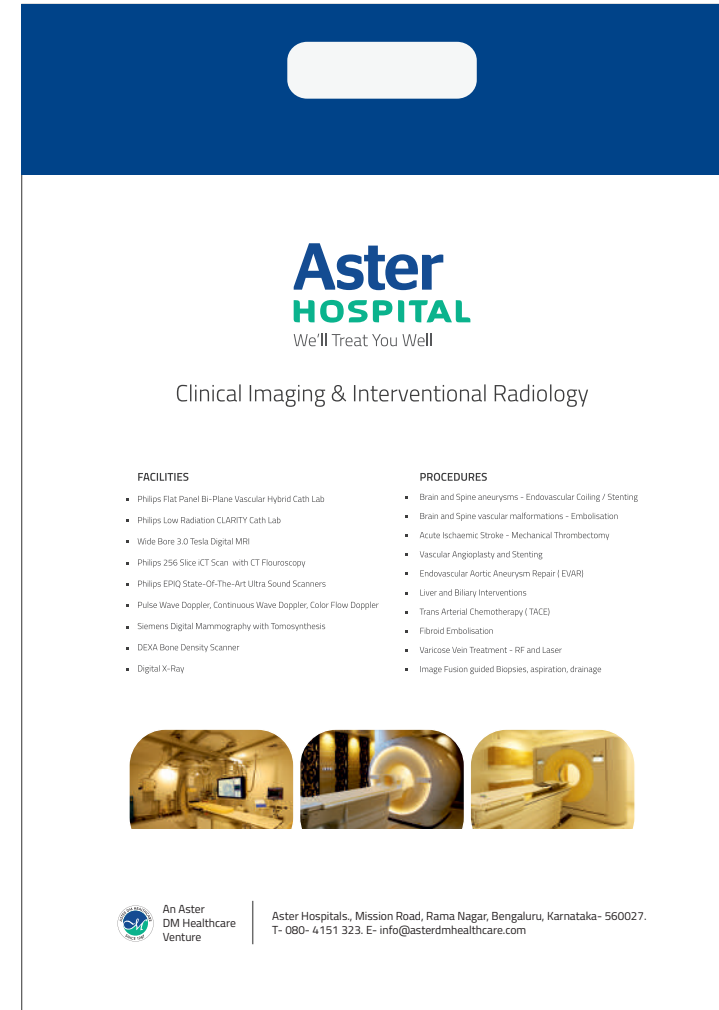
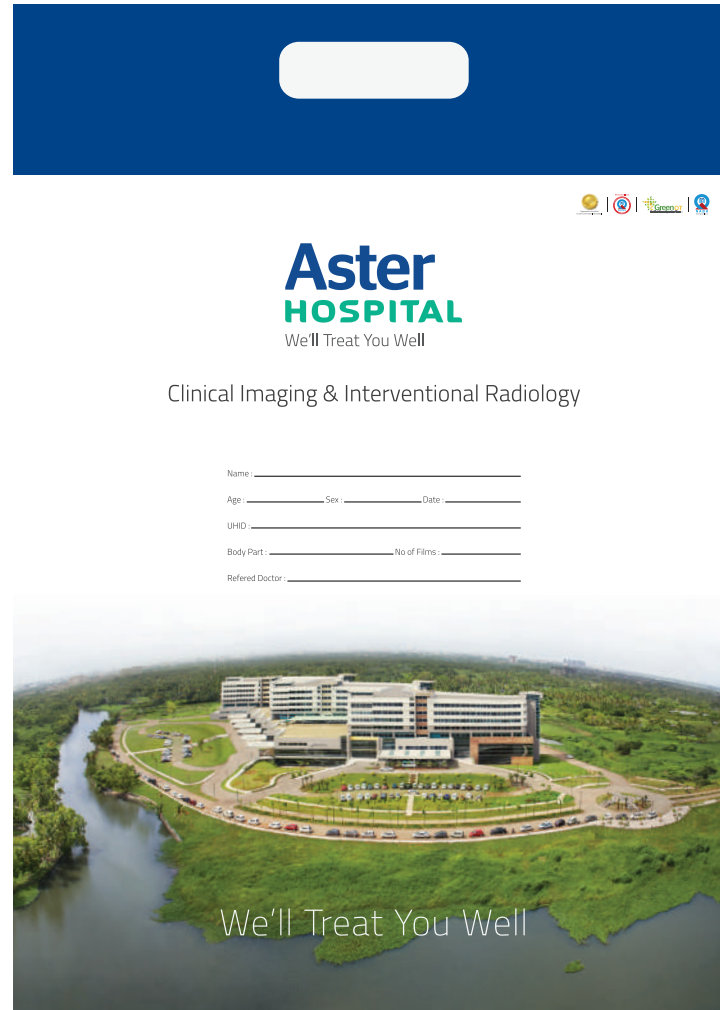

Size: (38 (W) x 53 (H) cm
Paper: 300 GSM matte lamination

STATIONERY MEDICINE COVER

Aster
HOSPITAL
We'll Treat You Well



Name.....



Please take tablet/capsule/syrup

before Food after food

morning afternoon evening night

Remarks.....

Front



Powered by humanity



**ADD LIFE
TO LIVES
EVERY DAY**

Be an Aster Volunteer

astervolunteers.com



Back - Space For Cross Promotion

Size: A5
Paper : 80 GSM maplitho

STATIONERY VISITOR PASS

01

No : 001
Aster HOSPITAL We'll Treat You Well
COMPANION
Patient Name : UHID No : Bed No. : Date of Admission : Attendant's Name :
(Please return this pass to the Billing Section at the time of discharge)

1. Access allowed only with the card.
2. This card should be in the possession of the attendant at all times and all places.
3. In case of loss of card, please report to health coordinator for a new card.
4. This card entitles the attendant to visit cafeteria, diagnostic areas where patients has been moved.

03

No : 001
Aster HOSPITAL We'll Treat You Well
VENDOR
Name : Company :

1. Visitor will not be allowed without this card.
2. Please display your card at all times during your presence in the hospital.
3. Please handover the card to the security desk on exit.

02

No : 001
Aster HOSPITAL We'll Treat You Well
VISITOR
Patient Name : UHID No : Bed No. Ward No : Date of Admission : Visitor's Name :
(Please return this pass to the Billing Section) Note : Visitors restricted to 1 at a time

1. Visitor will not be allowed without this card.
2. This pass should be in the possession of the Visitor at all times and at all places wherever the visitor moves around the hospital.
3. This pass entitles the visitor to visit cafeteria diagnostic areas where patient has been moved.
4. This pass does not entitles the visitor to stay with the patient in the ward or room.
5. Visiting Hours :
 - All Days
11 am - 12 noon & 4 pm To 6 pm
 - Sunday
4 pm - 7 pm

04

No : 001
Aster HOSPITAL We'll Treat You Well
VISITOR (Non Patient)
Name :

1. Visitor will not be allowed without this card.
2. Please display your card at all times during your presence in the hospital.
3. Please handover the card to the security desk on exit.

STATIONERY

PARKING STICKER

3 inch



3 inch



STATIONERY POWERPOINT TEMPLATE



TITLE OF THE PRESENTATION
Sub-Title

Aster
HOSPITAL
We'll Treat You Well

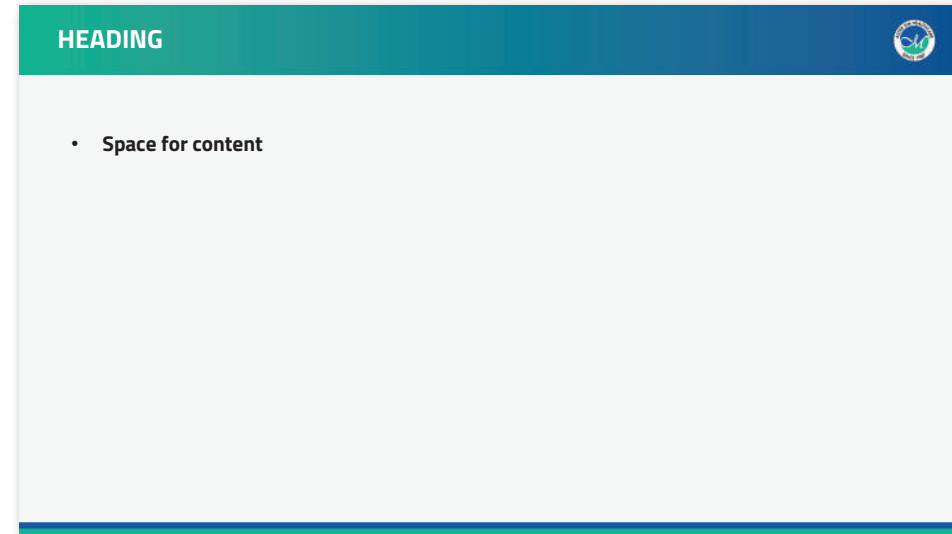

HEADING

- Space for content

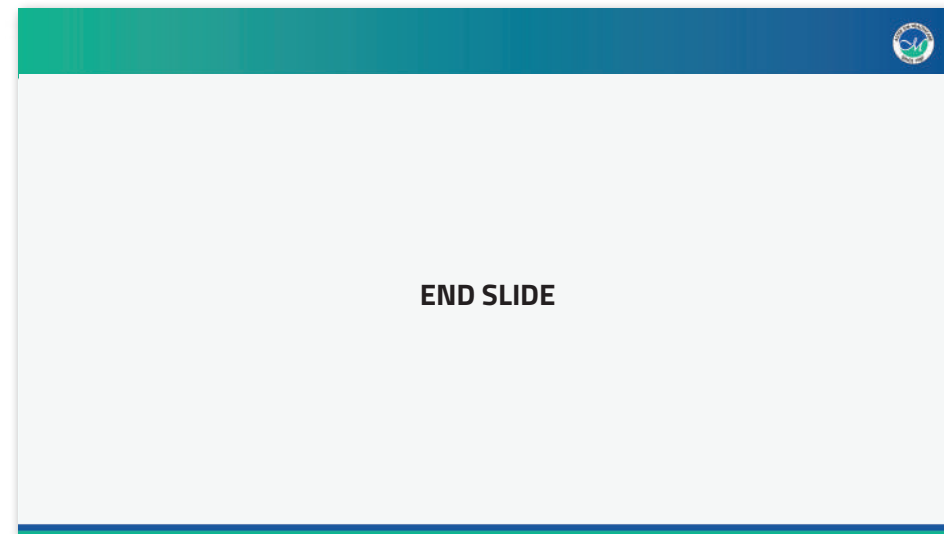

END SLIDE

STATIONERY

E-MAIL SIGNATURE TEMPLATE

First Name Last Name

Designation - Department



Aster DM Healthcare

Awfis, 2nd floor, 27 & 27/1, Renaissance Centre, Mission Road,
Sampangi Rama Nagar, Bengaluru, Karnataka 560027, India

M : + 91 00 000 0000

E : info@asterdmhealthcare.com

www.asterhospitals.in

Aster
HOSPITAL



We'll Treat You Well



ASTER HOSPITAL BACKDROP





ASTER HOSPITAL PRINT COMMUNICATION

Vertical Ad	60
-------------	----

Horizontal Ad	61
---------------	----

The layouts are only for logo placement and spacing reference

PRINT COMMUNICATION VERTICAL AD



**STROKE PATIENTS RECOVER BETTER,
IF TREATED WITHIN AN HOUR.**



**REMEMBER FASTER.
REMEMBER ASTER.**



- F** Face - Drooping on One Side
- A** Arm & Leg - Weakness
- S** Stability - Giddiness
- T** Talking - Slurring of Speech
- E** Eye - Blurred Vision
- R** React - Take Action

Why choose Aster?

- Comprehensive stroke care right from prevention, early intervention, diagnosis, management up to rehabilitation
- Trained stroke neurologists, nurses, interventional radiologists available all under one roof
- Advanced interventions including coiling and clipping of aneurysms available

CALL XXXX XXXXX
or visit www.asterhospitals.in

CA-37, 24th Main Rd, 1st Phase, J. P. Nagar,
Bengaluru, Karnataka 560078

Follow Aster on :    

Aster
HOSPITAL
We'll Treat You Well

PRINT COMMUNICATION HORIZONTAL AD

**STROKE PATIENTS
RECOVER BETTER,
IF TREATED
WITHIN AN HOUR.**

**REMEMBER FASTER.
REMEMBER ASTER.**

- F** Face - Drooping on One Side
- A** Arm & Leg - Weakness
- S** Stability - Giddiness
- T** Talking - Slurring of Speech
- E** Eye - Blurred Vision
- R** React - Take Action

Why choose Aster?

- Comprehensive stroke care right from prevention, early intervention, diagnosis, management up to rehabilitation
- Trained stroke neurologists, nurses, interventional radiologists available all under one roof
- Advanced interventions including coiling and clipping of aneurysms available

CALL 080 46414641
or visit www.asterbangalore.com

CA-37, 24th Main Rd, 1st Phase, J. P. Nagar,
Bengaluru, Karnataka 560078

Follow AsterBangalore on :

Aster
HOSPITAL
We'll Treat You Well

ASTER HOSPITAL - OUTDOOR COMMUNICATION

Vertical Billboard	62
--------------------	----

Horizontal Billboard	63
----------------------	----

The layouts are only for logo placement and spacing reference

OUTDOOR COMMUNICATION





VERTICAL BILLBOARD

**DROOPING OF FACE
IS A SIGN OF STROKE.**

Recognize this symptom at the earliest
and save a stroke patient.

To Know more & Book an appointment,
CALL XXXXX XXXXX
or visit www.asterhospitals.in

Aster Prime Hospitals, Plot No 4, HMDA Maitrivanam,
Satyam Theatre Rd, Srinivasa Nagar, Ameerpet, Hyderabad

Follow Aster    

Aster
HOSPITAL

We'll Treat You Well

OUTDOOR COMMUNICATION HORIZONTAL BILLBOARD



**DROOPING OF FACE
IS A SIGN OF STROKE.**

Recognize this symptom at the earliest
and save a stroke patient.

- F** Face - Drooping on One Side
- A** Arm & Leg - Weakness
- S** Stability - Giddiness
- T** Talking - Slurring of Speech
- E** Eye - Blurred Vision
- R** React - Take Action

To Know more & Book an appointment,
CALL XXXXX XXXXX
or visit www.asterhospitals.in

Aster Prime Hospitals, Plot No 4, HMDA Maitrivanam,
Satyam Theatre Rd, Srinivasa Nagar, Ameerpet, Hyderabad

Follow Aster    

**Aster
HOSPITAL**
We'll Treat You Well

ASTER HOSPITAL SIGNAGES

Extended Logo

64

Stacked Logo

65

SIGNAGE

EXTENDED LOGO

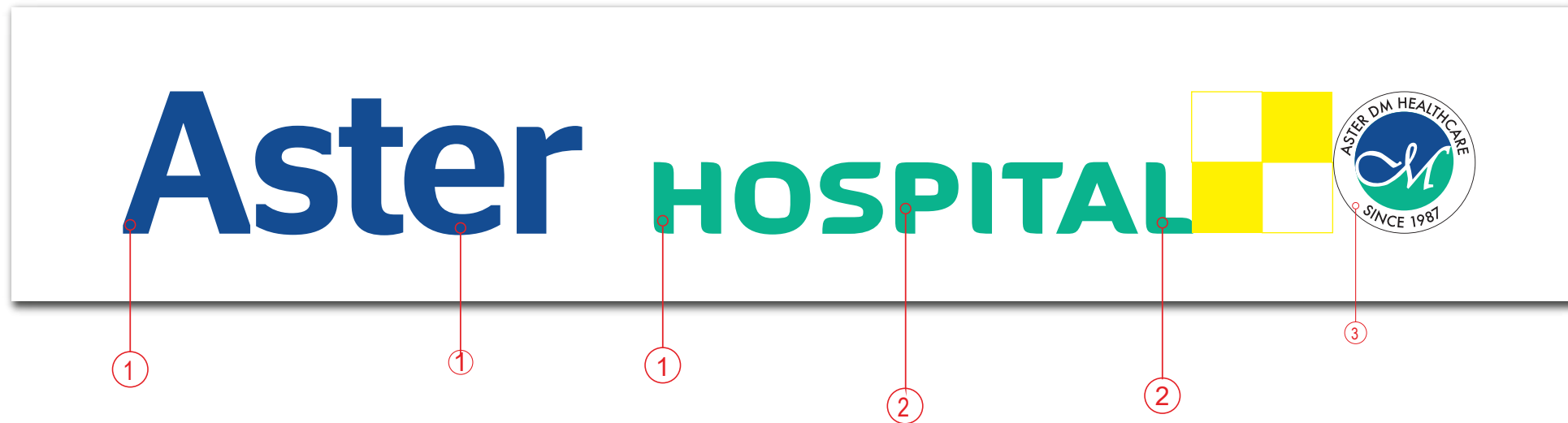

①

3D INDIVIDUAL LETTERS MADE OF 2.8MM ALUMINUM SHEET POWDER COATED SHOULD MATCH THE PANTONE 7687 C
60MM 3D EMBOSSED LETTERS (ACRYLIC COLTOR REFMODEN GLAS M327 BLUE CAST ACRYLIC)
FACE LIT LETTERS (6000K LED STRIPS)

③

Aster DM Healthcare- 3D 2.8MM ALUMINUM SHEET WHITE POWDER COATED
ROUND LOGO PRINTED ON LIGHT PASS VINYL AND UV LAMINATION MOUNTED ON 60MM OPAL WHITE ACRYLIC
GRAPHICS PRINTED SHOULD MATCH THE BELOW COLORS:
BLUE COLOR SHOULD MATCH BLUE VINYL REF AVERY 4517 TF DARK BLUE (REF: 375623)
GREEN COLOR SHOULD MATCH GREEN VINYL REF AVERY 4539 TF TURQUOISE (REF: 370355)

②

3D INDIVIDUAL LETTERS MADE OF 2.8MM ALUMINUM SHEET POWDER COATED SHOULD MATCH THE PANTONE 339 C
60MM 3D EMBOSSED OPAL WHITE ACRYLIC LETTERS WITH VINYL FASCIA (VINYL RE.: AF.: AVERY 4539 TF TURQUOISE)
FACE LIT LETTERS (6000K LED STRIPS)

SPECIAL NOTE:

FOR THE SIGN LETTERS WHICH ARE LESS THAN 1 METER HEIGHT SHOULD BE THE DEPTH OF 60MM
AND SIGN LETTERS WHICH ARE MORE THAN 1 METER AND LESS THAN 2METER SHOULD BETHE DEPTH OF 100MM

SIGNAGE

STACKED LOGO



1

3D INDIVIDUAL LETTERS MADE OF 2.8MM ALUMINUM SHEET POWDER COATED SHOULD MATCH THE PANTONE 7687 C
60MM 3D EMBOSSED LETTERS (ACRYLIC COLTOR REFMODEN GLAS M327 BLUE CAST ACRYLIC)
FACE LIT LETTERS (6000K LED STRIPS)

2

3D INDIVIDUAL LETTERS MADE OF 2.8MM ALUMINUM SHEET POWDER COATED SHOULD MATCH THE PANTONE 339 C
60MM 3D EMBOSSED OPAL WHITE ACRYLIC LETTERS WITH VINYL FASCIA (VINYL RE.: AF.: AVERY 4539 TF TURQUOISE)
FACE LIT LETTERS (6000K LED STRIPS)

3

Aster DM Healthcare- 3D 2.8MM ALUMINUM SHEET WHITE POWDER COATED
ROUND LOGO PRINTED ON LIGHT PASS VINYL AND UV LAMINATION MOUNTED ON 60MM OPAL WHITE ACRYLIC
GRAPHICS PRINTED SHOULD MATCH THE BELOW COLORS:
BLUE COLOR SHOULD MATCH BLUE VINYL REF AVERY 4517 TF DARK BLUE (REF: 375623)
GREEN COLOR SHOULD MATCH GREEN VINYL REF AVERY 4539 TF TURQUOISE (REF: 370355)

SPECIAL NOTE:

FOR THE SIGN LETTERS WHICH ARE LESS THAN 1 METER HEIGHT SHOULD BE THE DEPTH OF 60MM
AND SIGN LETTERS WHICH ARE MORE THAN 1 METER AND LESS THAN 2METER SHOULD BETHE DEPTH OF 100MM

ASTER HOSPITAL AMBULANCE BRANDING

Ambulance

66

VEHICLE BRANDING

AMBULANCE



ASTER HOSPITAL ACCESSORIES

Wall Clock

67

ACCESSORIES

WALL CLOCK



ASTER HOSPITAL - BED LINEN & CURTAINS

Bed Linen, Pillow Cover & Blanket	68
Bedside Curtains	69
Window - Blackout Blinds	70
Window - Curtains	71

ASTER HOSPITAL

BED LINEN, PILLOW COVER, BLANKET



Bed Linen

Colour - White

Mix (%) - Polyester - 60% , Cotton - 40%

Pillow cover

Colour - White

Mix (%) - Polyester - 60% , Cotton - 40%

Blanket

Colour - Camel Mink

Material - Polyester

ASTER HOSPITAL BEDSIDE CURTAINS



Tracks

Material - Aluminium
Powered coated with white colour
Thickness of power coating
60 to 70 microns

Curtains

100% Polyester
Nylon mesh (Net)
Size 16-18" from top
Stain retardant curtains

ASTER HOSPITAL

WINDOW - BLACKOUT BLINDS



Blackout Roller Blinds

Material: Stain resistant polymer coated fibre fabric with opaque openness

Colour: Milky White

The fabric shall be attached to the roller tube with high quality self adhesive tape.

ASTER HOSPITAL

WINDOW - CURTAINS



Curtain - 1

Hex - #c1b194
Material - Polyester
Self woven fabric

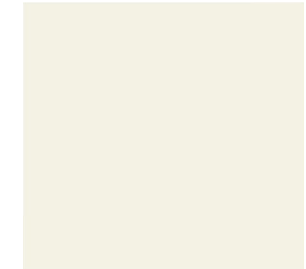

Curtain - 2

Hex - #F3F0E3
Material - Sheer cloth

ASTER HOSPITAL UNIFORMS - INDIA

Doctor's Coat/ Apron	72
Doctor's Scrub	73
Nurses - Male & Female	74
Nurses Aid	75
Customer Relations – Male	76
Customer Relations – Female	77
Pharmacy / Technicians	78
Maternity Wear	79
Security	80
Name Tag	81
Badge	82
Shoes	83

UNIFORM

DOCTOR'S APRON

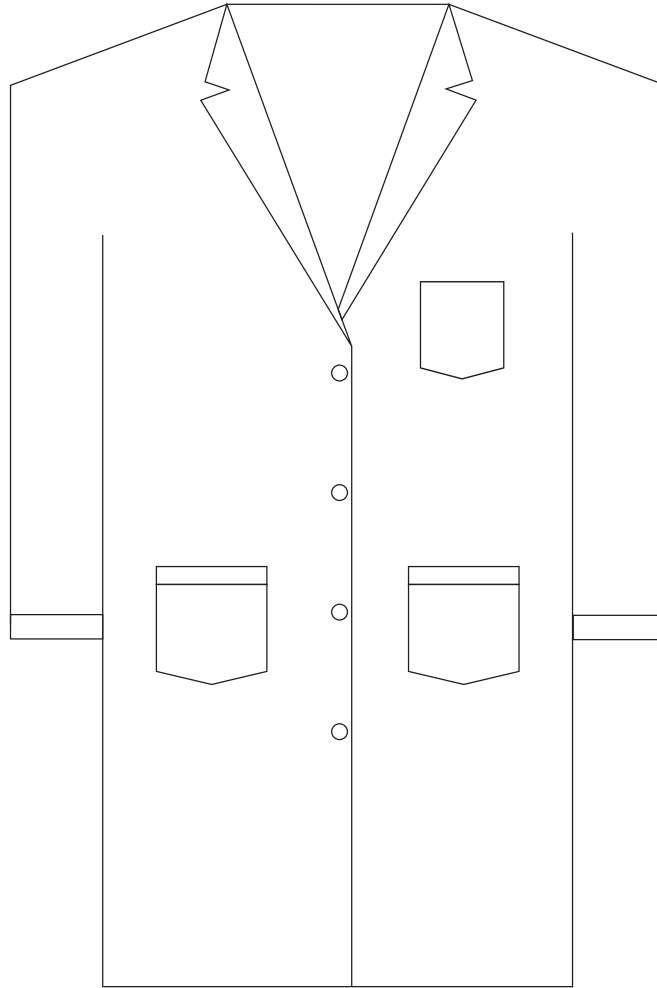

Gabardine Fabric White Polyester 30% & Cotton 70%

UNIFORM

DOCTORS SCRUB



Doctor Scrub



Doctor Scrub

Logo



3 x 3 cm

UNIFORM

MALE & FEMALE NURSE



Green - Gabardine / Twill Fabric, 70% polyester & 30% cotton

Blue - Terry Cotton, Navy Blue, 65% polyester & 35% cotton

Logo



3 x 3 cm

Aster
HOSPITAL



Vertical Logo
2 cm H

UNIFORM

NURSING AID



Pink - Gabardine / Twill Fabric, 70% polyester & 30% cotton

Blue - Terry Cotton, Navy Blue, 65% polyester & 35% cotton

Logo



3 x 3 cm

Aster
HOSPITAL



Vertical Logo
2 cm H

UNIFORM - MALE

CUSTOMER RELATIONS



UNIFORM - FEMALE

CUSTOMER RELATIONS



UNIFORM

PHARMACY, TECHNICIANS

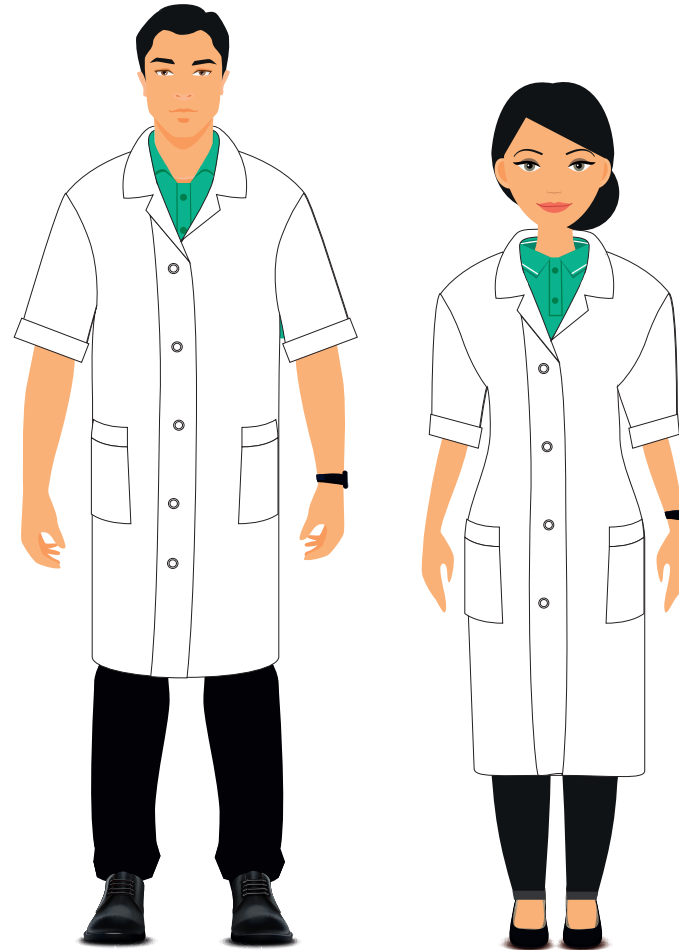

Gabardine Fabric White Polyester 30% & Cotton 70%

UNIFORM MATERNITY WEAR



**UNIFORM
SECURITY**



UNIFORM NAME TAG



Size- 70 mm*25 mm, Metal Badge with UV printing

UNIFORM BADGE



**UNIFORM
SHOES**



ASTER HOSPITAL UNIFORMS - GCC

Doctor's Apron	84
Male & Female Nurse	85
Male & Female Nurse Officer	86
Female Nurse Manager	87
Male Nurse Manager	88
OT Scrub Suit	89
NICU Scrub Suit	90
ICU Scrub Suit	91
ER Scrub Suit	92
Labour Room Scrub Suit	93
General/ Well Baby Scrub Suit	94
Support Staff	95
Office Staff	96

UNIFORM
DOCTOR'S APRON

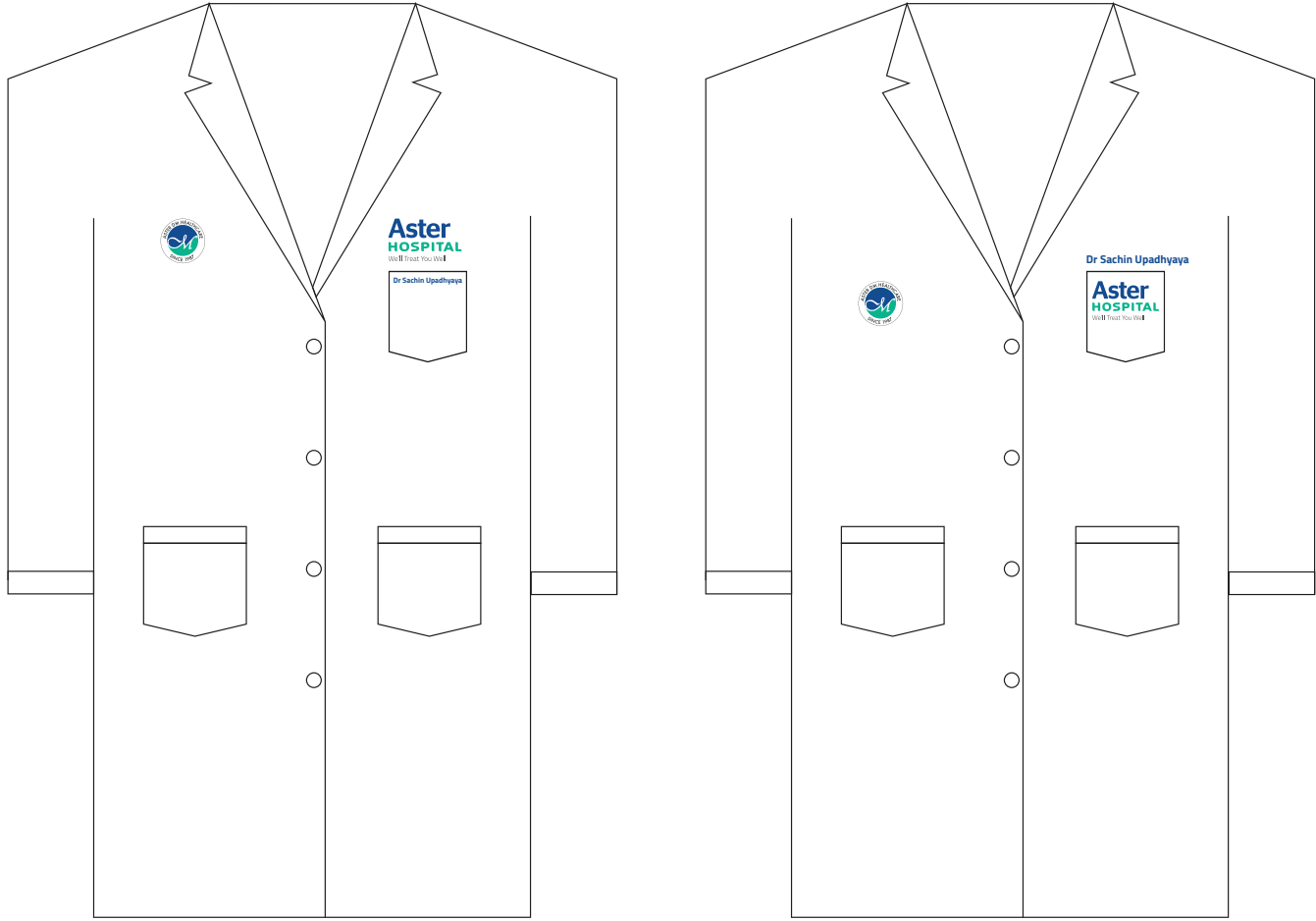

Gabardine Fabric White 65% polyester & 35% cotton

Logo



W 2.5cm X 2.5cm H



Vertical logo width x 2.5 cm Height

UNIFORM

MALE & FEMALE NURSE

Male nurse



Female nurse

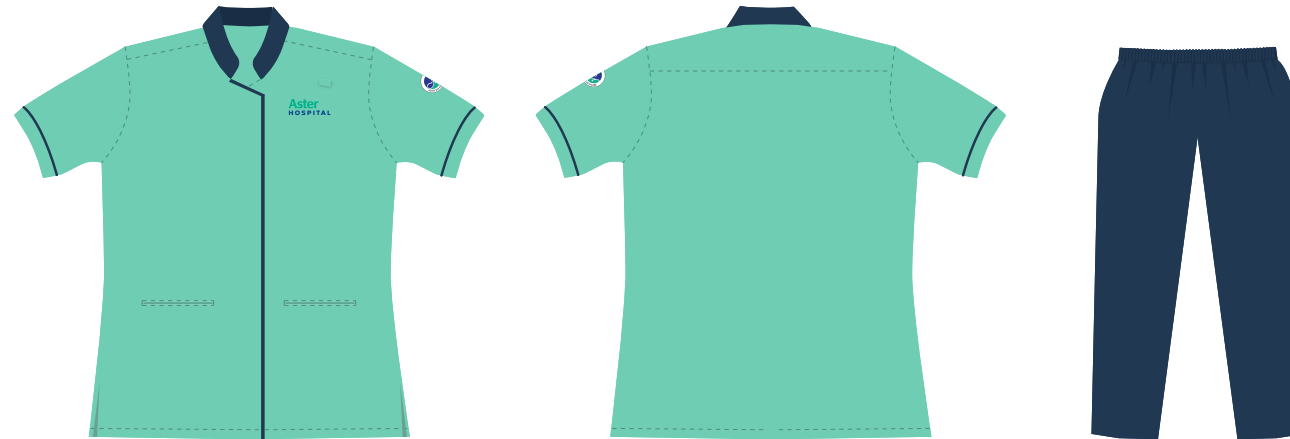

Green - Gabardine / Twill Fabric, 70% polyester & 30% cotton

Blue - Terry Cotton, Navy Blue, 65% polyester & 35% cotton

Logo



3 x 3 cm

Aster
HOSPITAL



Vertical Logo
2 cm H



PANTONE 7687 C



PANTONE 339 C

UNIFORM

MALE & FEMALE NURSE OFFICER

Male nurse officer

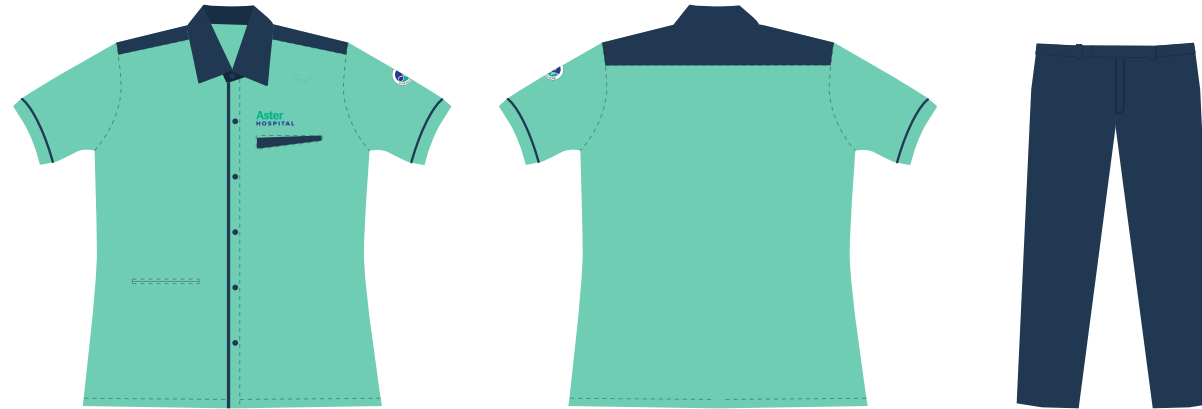

Female nurse officer

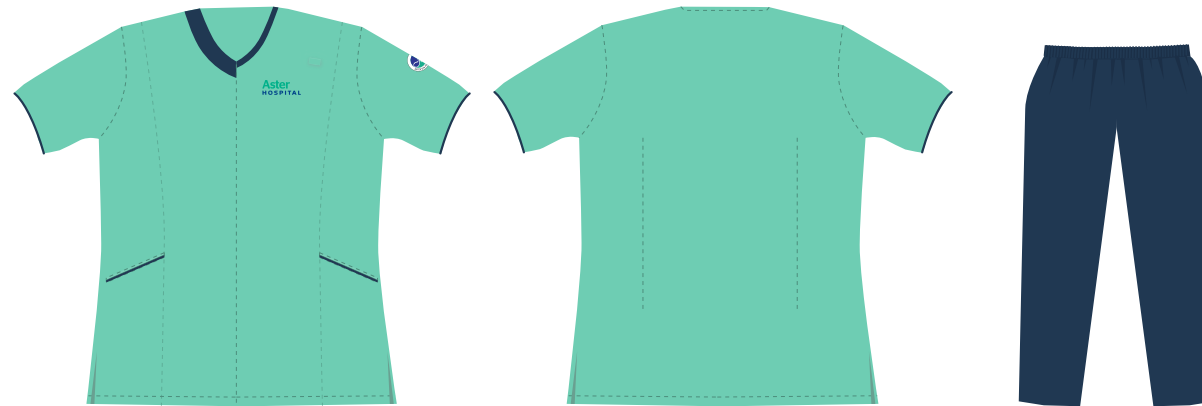

Green - Gabardine / Twill Fabric, 70% polyester & 30% cotton

Blue - Terry Cotton, Navy Blue, 65% polyester & 35% cotton

Logo



3 x 3 cm

Aster
HOSPITAL



Vertical Logo
2 cm H



PANTONE 7687 C



PANTONE 339 C

UNIFORM

FEMALE NURSE MANAGER



Blazer

Colour : Navy Blue
Material : Sapphire Woolen Mix
Mill : Raymond
Mix (%) : Poly-65% , Wool-35%

Inner

Colour : Green
Material : Rayamon Cotton
Mill : Valji
Mix (%) : Poly-67% , Viscose-33%

Trouser

Colour : Navy Blue
Material : Sapphire Woolen Mix
Mill : Raymond
Mix (%) : Poly-65% , Wool-35%

UNIFORM

MALE NURSE MANAGER



Blazer

Colour : Navy Blue
Material : Sapphire Woolen Mix
Mill : Raymond
Mix (%) : Poly-65% , Wool-35%

Inner

Colour : Green
Material : Rayamon Cotton
Mill : Valji
Mix (%) : Poly-67% , Viscose-33%

Trouser

Colour : Navy Blue
Material : Sapphire Woolen Mix
Mill : Raymond
Mix (%) : Poly-65% , Wool-35%

UNIFORM

OT SCRUB SUIT



Logo



3 x 3 cm

UNIFORM

NICU SCRUB SUIT



Logo



3 x 3 cm

Aster
HOSPITAL



Vertical Logo
2 cm H

UNIFORM

ICU SCRUB SUIT



Logo



3 x 3 cm

Aster
HOSPITAL



Vertical Logo
2 cm H

UNIFORM ER SCRUB SUIT



Logo



3 x 3 cm

Aster
HOSPITAL



Vertical Logo
2 cm H

UNIFORM

LABOUR ROOM SCRUB SUIT



Logo



3 x 3 cm

Aster
HOSPITAL



Vertical Logo
2 cm H

UNIFORM

GENERAL / WELL BABY SCRUB SUIT



Logo



3 x 3 cm



Vertical Logo
2 cm H

UNIFORM SUPPORT STAFF



Logo



Aster
HOSPITAL



Aster



UNIFORM

OFFICE STAFF



Aster
HOSPITAL



Vertical Logo
2 cm H

THANK YOU

Aster Hospital Signage Guidelines

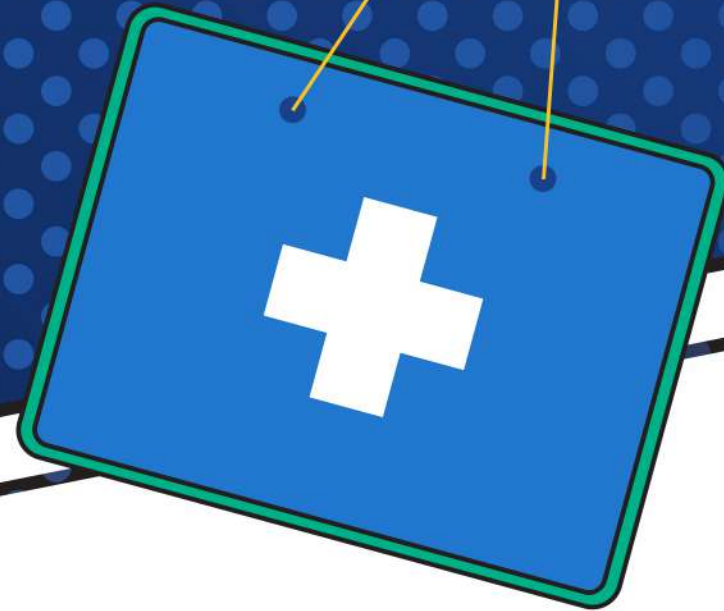

Why are signs everyone's best friend?

They always point in the right direction.

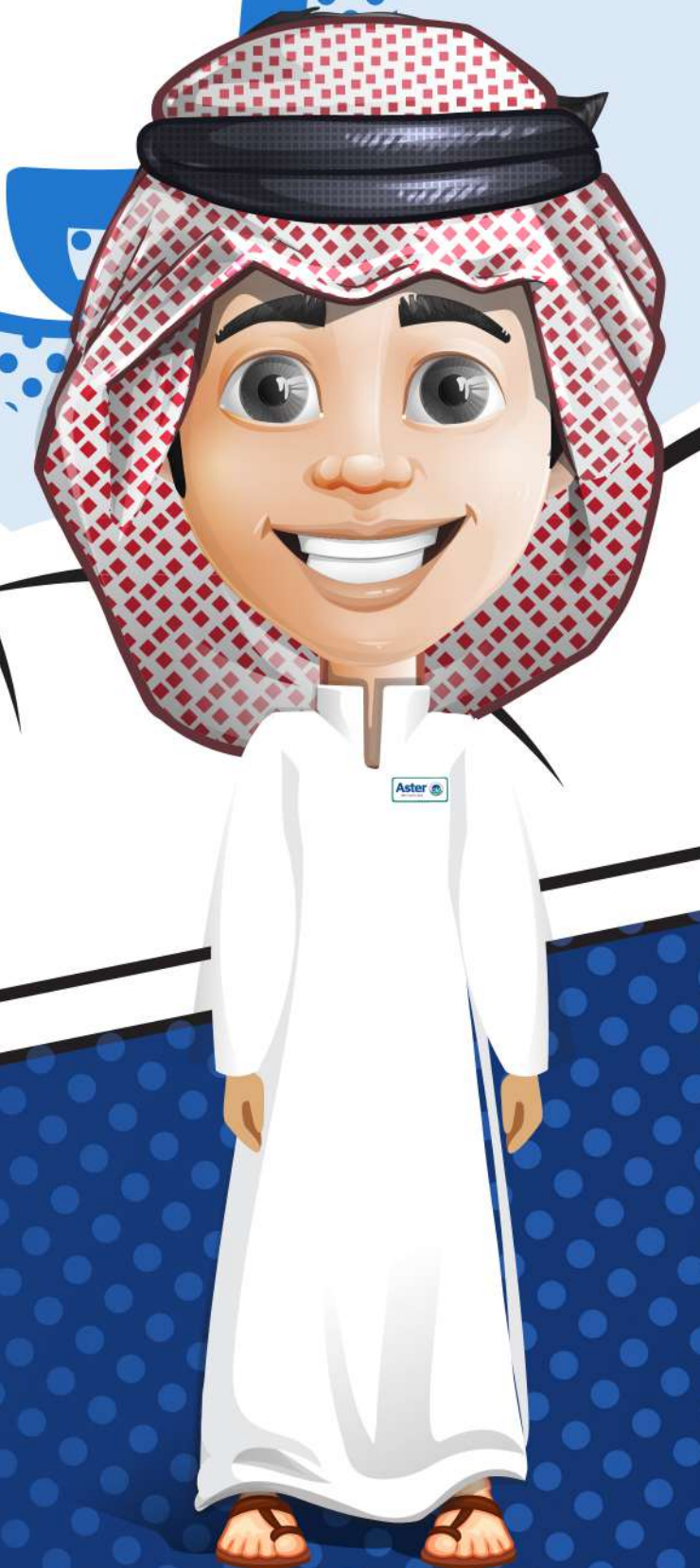

TABLE OF CONTENTS

EXTERNAL SIGNAGES

Facade	1
Pylon	2-3
Emergency	4
Emergency Direction	5
Parking	6-7
Entrance Glass Frosting	8-9

INTERNAL SIGNAGES

TYPES & SIZES OF SIGNAGES

Reception Hanging	10-11
Way Finding Hanging	12-13
Wall Mounted Way Finding	14-15
Floor Directory	16-17
Door Signages	
- Consultation Room & Number	18-19
- Room Signage	20
- IP Room Number	21-22
- Restroom	23-24
Bed Number	25-26

SIGNAGE DESIGNS

Reception Background	27-28
Aster Values Board	29-30
Hanging Signages	31-32
OPD	33-45
IP, OT & ICU	46-49
CSSD	50-51
Housekeeping	52
Restroom	53
Cafeteria	54-55
Facility	56-59
Radiology Signages	60
Administrative Office	61-64
Fire Safety	65-66

EXTERNAL SIGNAGES

FACADE SIGNAGE



C:100/M:80/Y:3/K:12



C:80/M:00/Y:60/K:00

Specification :

ACP Background: 50mmx25mm pipe thickness MS frame structure clad with ACP of approved colour and 1.2 mm (thickness of material) 3D aluminium trim cap channel letters powder coated to white colour raised as per the site requirement with front facia 3mm acrylic spray painted / vinyl pasted on the 040 Acrylic as per the brand colour, illuminated with LED.

Note: Size can be as per the site requirement.

PYLON



PYLON



C:100/M:80/Y:3/K:12



C:80/M:00/Y:60/K:00



C:13/M:100/Y:78/K:3

Specification :

50 - 100mm MS Pole Structure for the pillars surrounded with a MS Structure of 50mmx25mm box MS frame of 2mm thickness of square type tube, with a baseplate having 10mm bolt and nut thickness options underground cage with RCC structure clad with ACP and cast vinyl wrapped on ACP structure. The texts to be router cut and front side to be 10MM solid 040 laser cut letters illuminated with LED.

Note: Size can be as per the site requirement.



EMERGENCY SIGNAGE



Specification :

1.2mm thickness of 3D aluminium trim cap channel letters powder coated to red colour raised as per the site requirement and visibility with front facia 3MM Red Acrylic illuminated with red LED.

Note: Size can be as per the site requirement.

EMERGENCY DIRECTIONAL SIGNAGE



Specification :

100MM thickness box, MS frame fabrication clad with red ALU decor 4mm thick ACP with CNC router cutting of text. The texts to be at least 10MM solid 040 laser cut letters illuminated with LED.

Note: Size can be as per the site requirement.

PARKING SIGNAGES



PARKING SIGNAGES

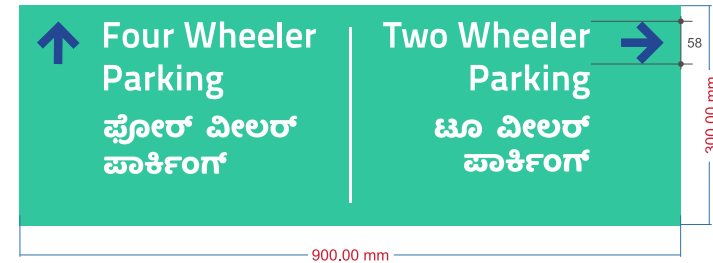
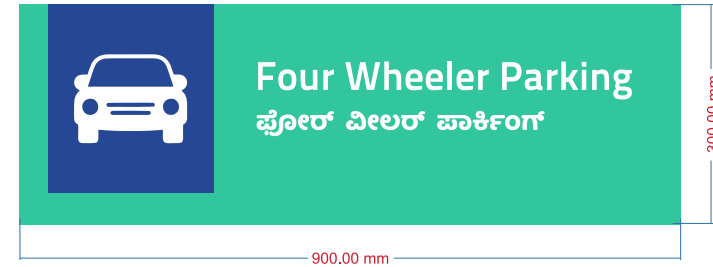

Specification: Anodized silver matt flat profile aluminium Sec 538 double side. Information to be printed on cast vinyl, laminated, and wrapped to 5mm WPC / Acrylic.
Fixing: Fixed with SS rope and to be placed 84" above the floor level.

Note: You may choose the sizes mentioned here or any other as per the site requirement.

ENTRANCE GLASS FROSTING



ENTRANCE GLASS FROSTING



Specification: Crystal series frosted Vinyl printing.

Fixing: Applied behind the glass and height of the film & logo to retain same. The width can vary on site condition.

INTERNAL SIGNAGES

TYPES & SIZES OF SIGNAGES

Reception Hanging	10-11
Way Finding Hanging	12-13
Wall Mounted Way Finding	14-15
Floor Directory	16-17
Door Signages	
- Consultation Room & Number	18-19
- Room Signage	20
- IP Room Number	21-22
- Restroom	23-24
Bed Number	25-26

RECEPTION HANGING SIGNAGE



RECEPTION HANGING SIGNAGE

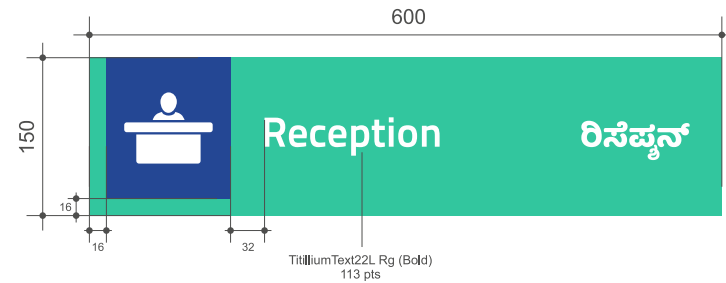
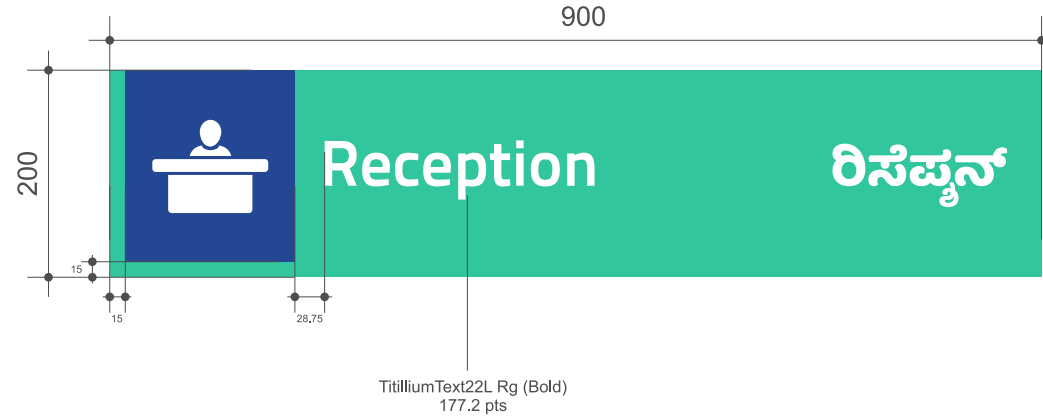

Specification: Anodized silver matt flat profile aluminium Sec 538 double side. Information to be printed on cast vinyl, laminated, and wrapped to 5mm WPC / Acrylic.
Fixing: Fixed with SS rope and to be placed 84" above the floor level.

WAY FINDING HANGING SIGNAGES



WAY FINDING HANGING SIGNAGES

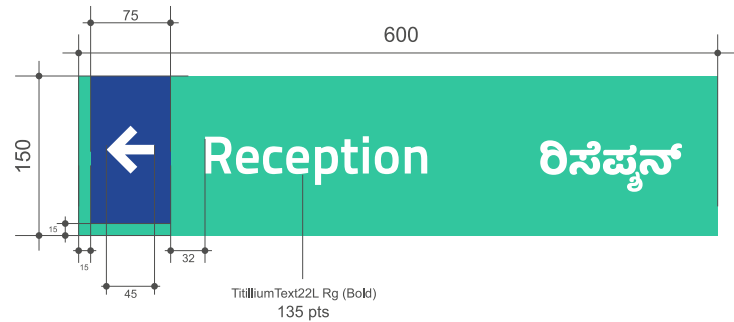
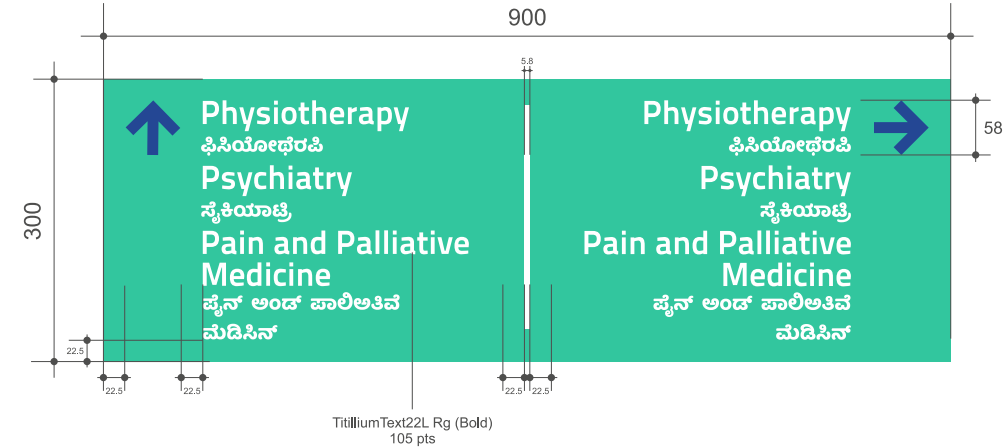
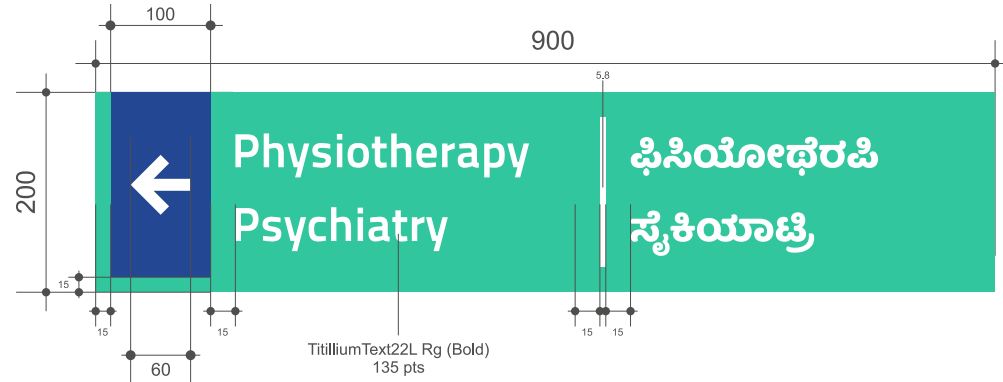

Specification: Anodized silver matt flat profile aluminium Sec 538 double side. Information to be printed on cast vinyl, laminated, and wrapped to 5mm WPC / Acrylic.
Fixing: Fixed with SS rope and to be placed 84" above the floor level.

WALL MOUNTED WAY FINDING SIGNAGES



WALL MOUNTED WAY FINDING SIGNAGES

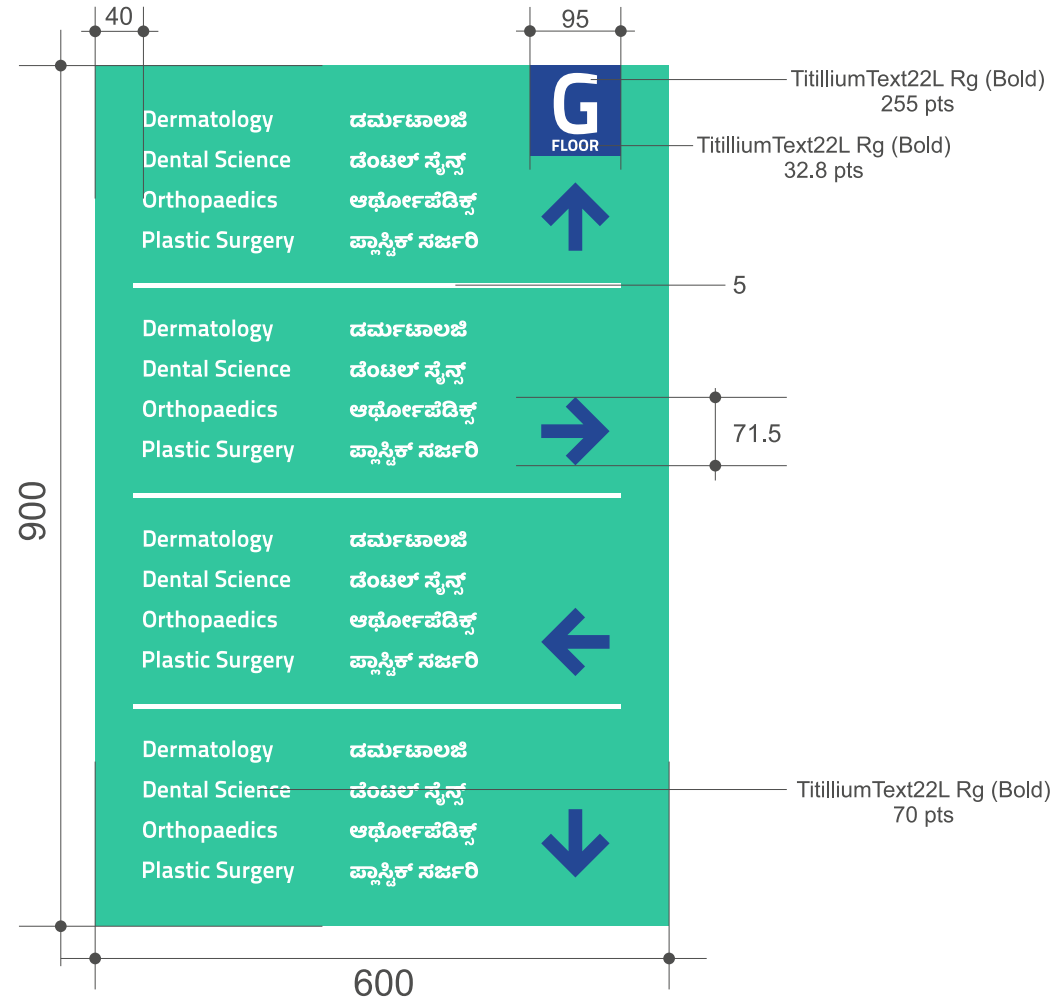

C:100/M:80/Y:3/K:12

C:80/M:00/Y:60/K:00

Specification: Anodized silver matt flat profile aluminium Sec 538 single side. Information to be printed on cast vinyl, laminated, and wrapped to 5mm WPC / Acrylic.
Fixing: Fixed with required fixtures and to be placed 36 - 48" above the floor level

FLOOR DIRECTORY



FLOOR DIRECTORY

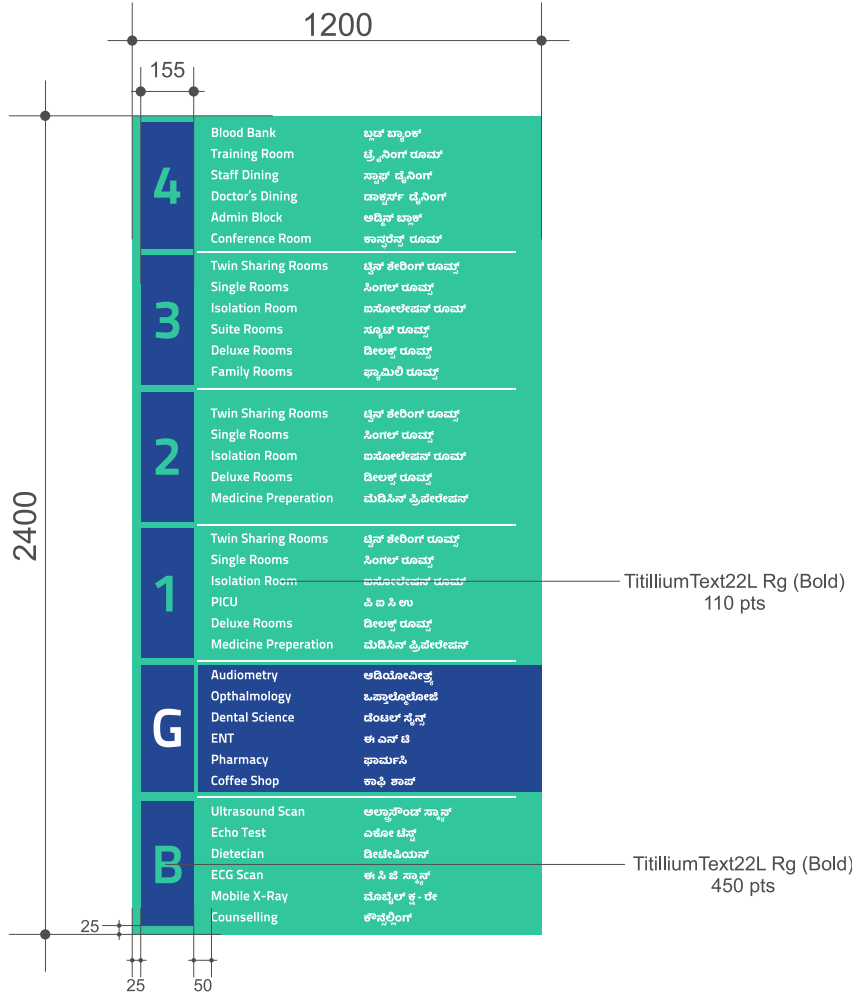

C:100/M:80/Y:3/K:12

C:80/M:00/Y:60/K:00

Specification :

Material: Anodized silver matt flat profile aluminium Sec 538 single side. Information to be printed on cast vinyl, laminated, and wrapped to 5mm WPC / Acrylic.

Fixing: Fixed with required fixtures and to be placed 12-18" above from the floor level.

Note: All dimension mentioned in "mm". In the creative Ground floor is highlighted as the floor directory is displayed in Ground floor. Similarly the respective floors can be highlighted when displayed in different floors.

DOOR SIGNAGES

Consultation Room & Number Signages (Door Mounted/ Perpendicular)



DOOR SIGNAGES

Consultation Room & Number Signages (Door Mounted/ Perpendicular)

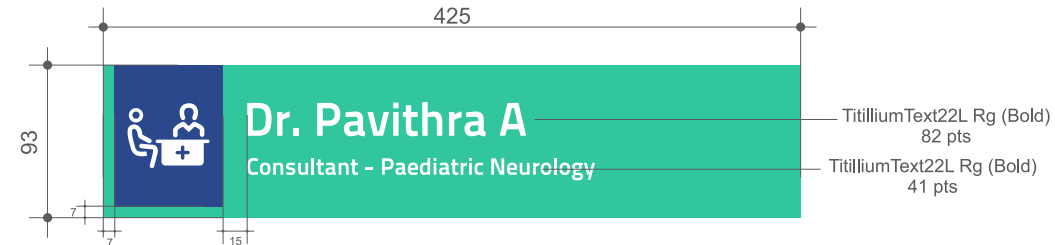

Specification :

Anodized silver matt flat profile aluminum with 2 end capes and a clear PVC. Information to be printed on cast vinyl and inserted.

Fixing: Fixed with required fixtures and to be placed 55" above from the floor level.

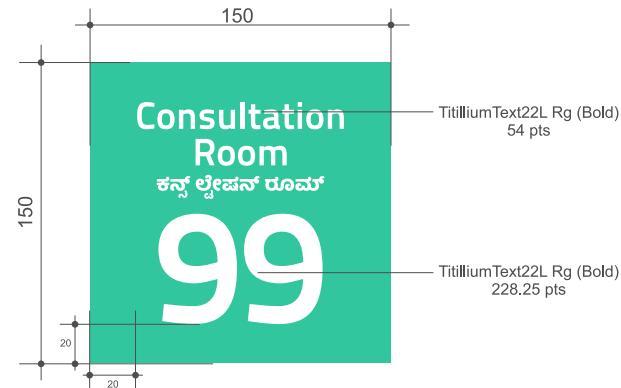

C:100/M:80/Y:3/K:12



C:80/M:00/Y:60/K:00

Specification :

Anodized silver matt flat profile aluminum with 2 end capes and a clear PVC. Information to be printed on cast vinyl and inserted.

Fixing: Perpendicular fixation with required fixtures and to be placed 78" above from the floor level.

DOOR SIGNAGES

Room Signages

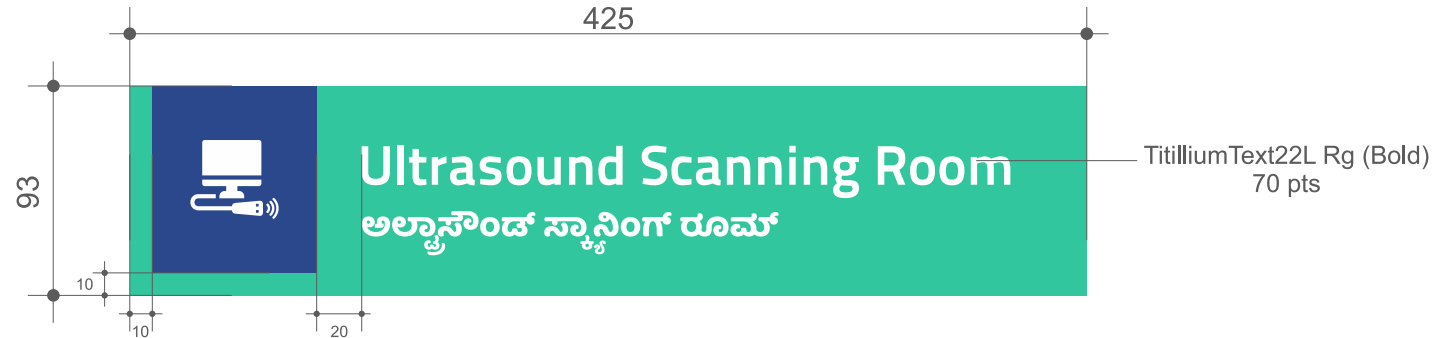

C:100/M:80/Y:3/K:12



C:80/M:00/Y:60/K:00

Specification :

Anodized silver matt flat profile aluminum with 2 end capes and a clear PVC. Information to be printed on cast vinyl and inserted.

Fixing: Fixed with required fixtures and to be placed 55" above from the floor level.

Note: The size specified here is only for door signage. If there is a requirement for placing speciality signage on the wall please go with the 1st size of wayfinding signage.

DOOR SIGNAGES

IP Room Number Signages



DOOR SIGNAGES

IP Room Number Signages

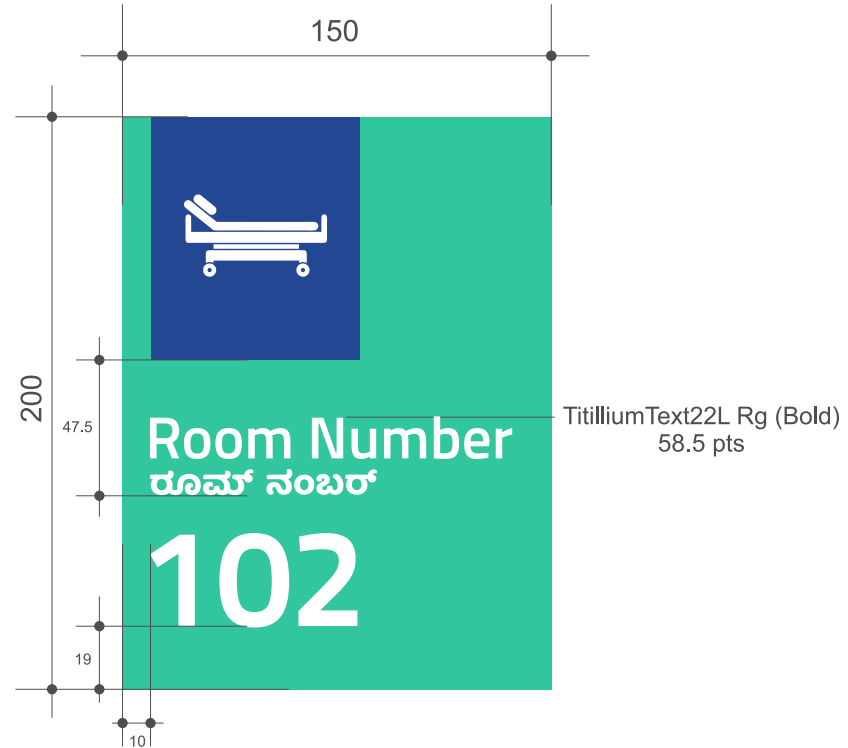

Specification :

Anodized silver matt flat profile aluminium with 2 end caps. Information to be printed on cast vinyl, laminated, and wrapped to the aluminium profile on 2 side (left & right)
Fixing: Fixed with required fixtures and to be placed 55" above from the floor level.

DOOR SIGNAGES

Restroom Signages



DOOR SIGNAGES

Restroom Signages

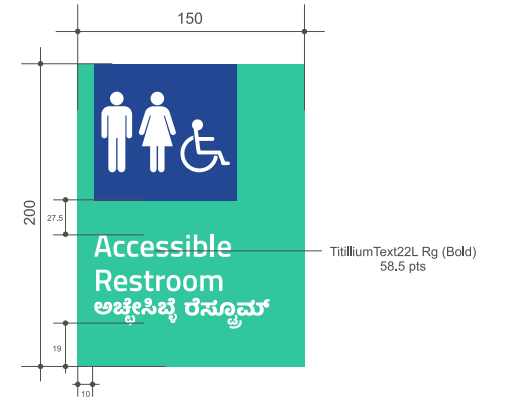
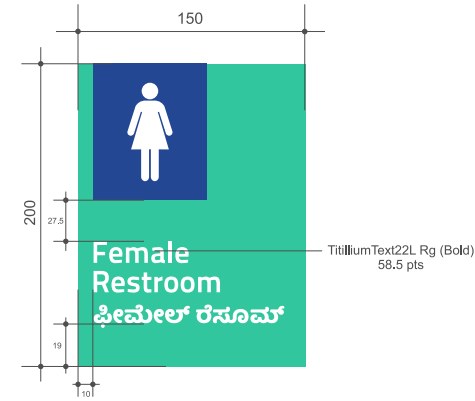
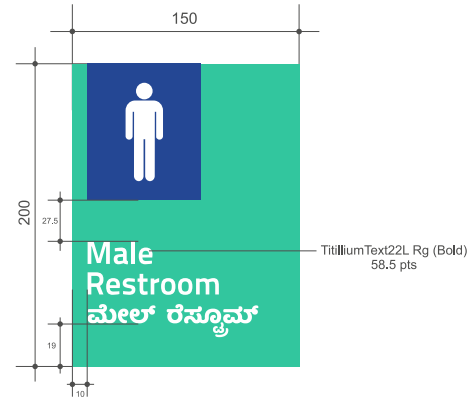
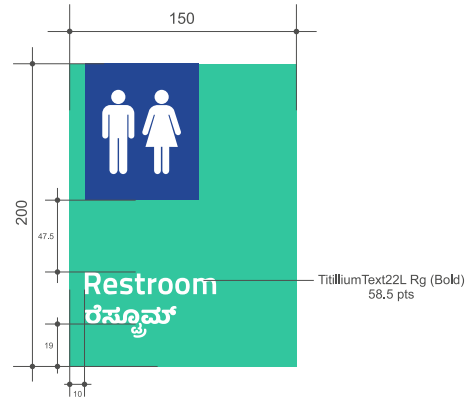

Specification :

Anodized silver matt flat profile aluminium with 2 end caps. Information to be printed on cast vinyl, laminated, and wrapped to the aluminium profile on 2 side (left & right)
Fixing: Fixed with required fixtures and to be placed 55" above from the floor level.

BED NUMBER SIGNAGES



BED NUMBER SIGNAGES

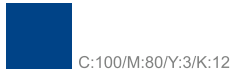
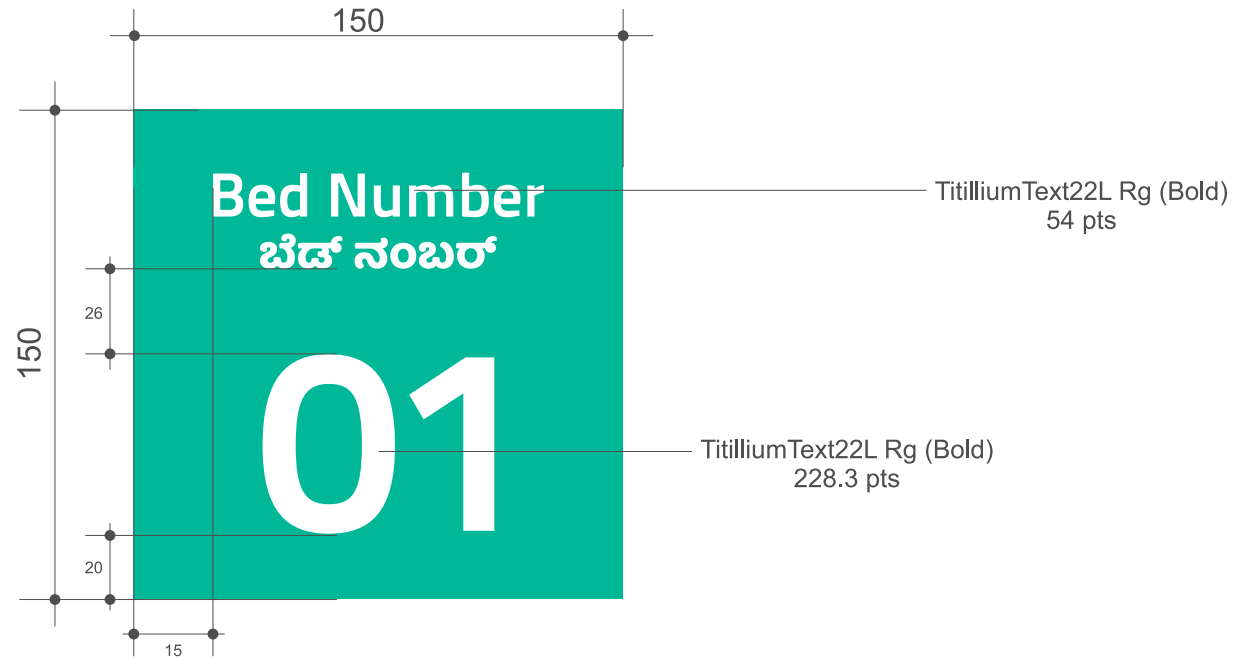

C:100/M:80/Y:3/K:12



C:80/M:00/Y:60/K:00

Specification :

Material : 5MM Sunboard with Eco Solvent Print & Matt Lamination

Fixing: Double sided 3M tape

SIGNAGE DESIGNS

Reception Background	27-28
Aster Values Board	29-30
Hanging Signages	31-32
OPD	33-45
IP, OT & ICU	46-49
CSSD	50-51
Housekeeping	52
Restroom	53
Cafeteria	54-55
Facility	56-59
Radiology Signages	60
Administrative Office	61-64
Fire Safety	65-66

RECEPTION BACKGROUND



C:100/M:80/Y:3/K:12



C:80/M:00/Y:60/K:00



C:00/M:00/Y:00/K:20

Specification:
18mm WPC router cutting and PU painting as per the brand colour and to be fixed with necessary tapes/glues

RECEPTION BACKGROUND



ASTER VALUES BOARD



ASTER VALUES BOARD

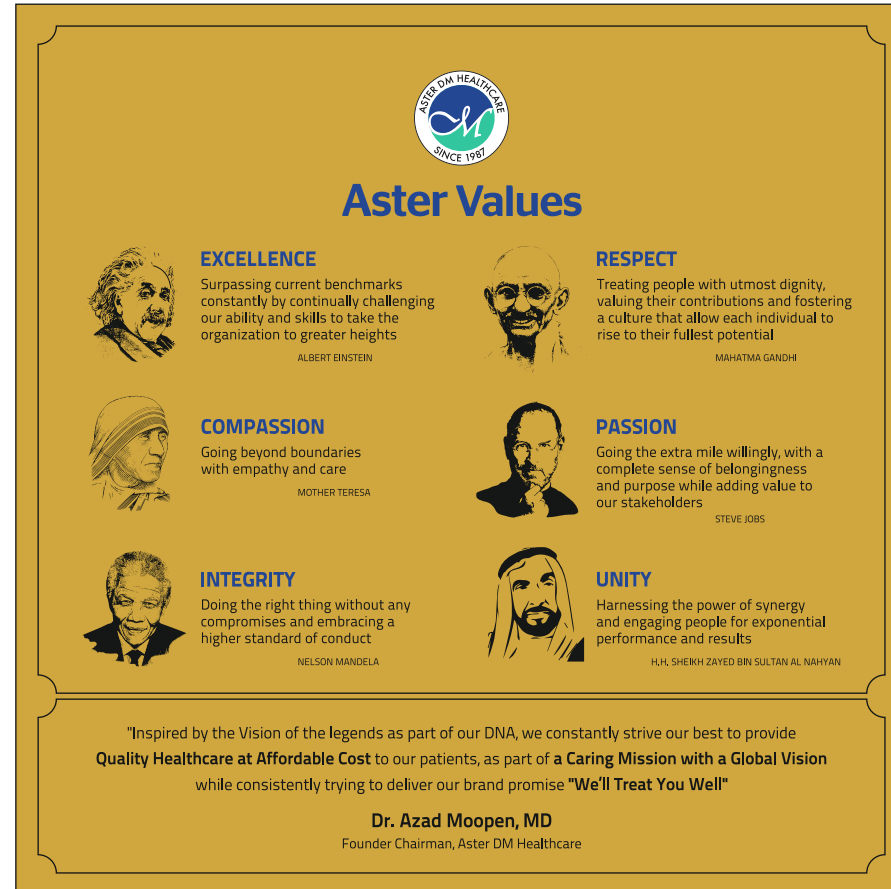

Specification: Made up of 12mm engineered wood with wood veneer layer glued together and patterned engraved in CNC router. The gold finish sheet to be cut by laser inlay on it. The laser cut gold finish sheet to have UV printed graphics and protective coat. L-angle metal reinforcement to be given on the frame and a keyhole mechanism for hanging.

Size: 42cm x 42cm

HANGING SIGNAGES

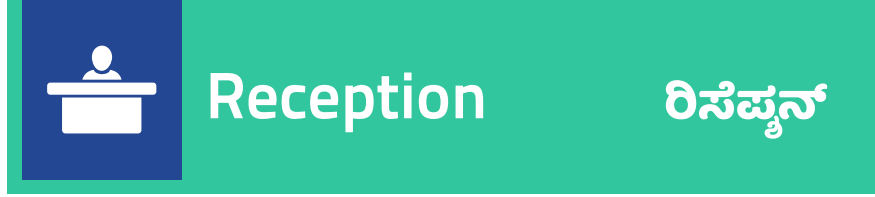

HANGING SIGNAGES



OPD SIGNAGES



Integrated Liver Care
ಇಂಟಿಗ್ರೇಟೆಡ್ ಲಿವರ್ ಕೇರ್



Pulmonology
ಪಲ್ಮೊನೊಲೊಜಿ



Orthopaedics
ಒರಥೋಪೆಡಿಕ್ಸ್



Cardiac Sciences
ಕಾರ್ಡಿಯಾಕ್ ಸೈನ್ಸಸ್



Neurosciences
ನೇಯುರೋಸೈಂಸ್



Paediatrics
ಪಿಡಿಯಾಟ್ರಿಕ್ಸ್

OPD SIGNAGES



Medical Gastroenterology
ಮೆಡಿಕಲ್ ಗ್ಯಾಸ್ಟ್ರೋಎಂಟರಾಲಜಿ



General Surgery
ಜನರಲ್ ಸರ್ಜರಿ



Fertility and IVF
ಫೆರ್ಟಿಲಿಟಿ & ಐವಿಫ್



Obstetrics & Gynaecology
ಒಬ್ಸ್ಟೆಟ್ರಿಕ್ಸ್ & ಜಿನಿಯೆಚೊಲೊಜಿ



Internal Medicine
ಇಂಟರ್ನಲ್ ಮೆಡಿಸಿನ್



Critical Care Medicine
ಕ್ರಿಟಿಕಲ್ ಕೇರ್ ಮೆಡಿಸಿನ್

OPD SIGNAGES



Multi-Organ Transplant

ಮಲ್ಟಿ-ಆರ್ಗನ್ ಟ್ರಾನ್ಸ್‌ಪ್ಲಾಂಟ್



Renal Sciences

ರೆನಲ್ ಸೈನ್ಸಸ್



Plastic Reconstructive & Aesthetic Surgery

ಪ್ಲಾಸ್ಟಿಕ್ ರೆಕಾನ್ಸ್ಟ್ರಕ್ಟಿವ್ & ಅಈಸ್ಟೆಟಿಕ್ ಸರ್ಜರಿ



Oncology

ಅಂಕೋಲಾಜಿ



Craniomaxillofacial Surgery

ಕ್ರೇನಿಯೋಮ್ಯಾಕ್ಸಿಲೋಫೇಶಿಯಲ್ ಸರ್ಜರಿ



Bariatric & Metabolic Surgery

ಬರಿಯಾಟ್ರಿಕ್ ಮೆಟಾಬಾಲಿಕ್ ಸರ್ಜರಿ

OPD SIGNAGES



Vascular Surgery
ವಾಸ್ಕುಲರ್ ಸರ್ಜರಿ



Endocrinology & Diabetology
ಎಂಡೋಕ್ರಿನೋಲಜಿ & ಡೈಯಾಬಿಟಾಲಜಿ



Rheumatology
ರುಮಟೋಲಜಿ



ENT
ಈ ಎನ್ ಟಿ



Anesthesiology
ಅನೆಸ್ಥೆಸಿಯೋಲಜಿ



Dermatology
ಡರ್ಮಟಾಲಜಿ

OPD SIGNAGES



Nuclear Medicine

ನ್ಯೂಕ್ಲಿಯರ್ ಮೆಡಿಸಿನ್



Ayurved

ಆಯುರ್ವೇದ



Pain & Palliative Medicine

ಪೈನ್ & ಪಲಿಯೇಟಿವ್ ಮೆಡಿಸಿನ್



**Physical Medicine
& Rehabilitation**

ಫಿಸಿಕಲ್ ಮೆಡಿಸಿನ್ & ರಿಹ್ಯಾಬಿಲಿಟೇಷನ್



Dentistry

ಡೆಂಟಿಸ್ಟ್ರಿ



Nutrition & Dietetics

ನ್ಯೂಟ್ರಿಷನ್ & ಡೈಯೆಟಿಕ್ಸ್

OPD SIGNAGES



Interventional Radiology

ಇಂಟರ್ವೆನ್ಯಾಷನಲ್ ರೇಡಿಯಾಲಜಿ



Geriatrics

ಗೆರಿಯಾಟ್ರಿಕ್ಸ್



Audiometry

ಆಡಿಯೋಮಿಟ್ರಿ



**Psychiatry &
Counselling Services**

ಸೈಕಿಯಾಟ್ರಿ & ಕೌನ್ಸೆಲ್ಲಿಂಗ್ ಸರ್ವಿಸಸ್



Ophthalmology

ಒಪ್ತಾಲ್ಮಾಲಜಿ



**Infectious Disease
Medicine**

ಇನ್ಫೆಕ್ಷನ್ ಡಿಸೀಸ್ ಮೆಡಿಸಿನ್

OPD SIGNAGES



Fast Track Unit

ಫಾಸ್ಟ್ ಟ್ರ್ಯಾಕ್ ಯುನಿಟ್



Emergency Instruction

ಎಮರ್ಜೆನ್ಸಿ ಇನ್ ಸ್ಟ್ರಕ್ಷನ್



Triage

ಟ್ರಿಯೇಜ್



Counselling Room

ಕೌನ್ಸೆಲ್ಲಿಂಗ್ ರೂಮ್



Isolation Room

ಐಸೋಲೇಷನ್ ರೂಮ್

OPD SIGNAGES



ECHO Room
ಎಕೋ ರೂಮ್



TMT
ಟಿ ಎಮ್ ಟಿ



Assessment Room
ಅಸೆಸ್ಮೆಂಟ್ ರೂಮ್



Dressing Room
ಡ್ರೆಸಿಂಗ್ ರೂಮ್



ECG Room
ಈ ಸಿ ಜಿ ರೂಮ್



Laboratory
ಲ್ಯಾಬೋರೇಟರಿ

OPD SIGNAGES



Pathology
ಪ್ಯಾಥೋಲಜಿ



Sample Collection Area
ಸ್ಯಾಂಪಲ್ ಕಲೆಕ್ಷನ್ ಏರಿಯಾ



Blood Bank
ಬ್ಲಡ್ ಬ್ಯಾಂಕ್



Immunohistochemistry Room
ಇಮ್ಯುನೊಹಿಸ್ಟೊಚೆಮಿಸ್ಟ್ರಿ ರೂಮ್

OPD SIGNAGES



Dialysis
ಡಯಾಲಿಸಿಸ್



Day Care
ಡೇ ಕೇರ್



Dental Procedure Room
ಡೆಂಟಲ್ ಪ್ರೊಸೀಜರ್ ರೂಮ್



Endoscopy
ಎಂಡೋಸ್ಕೋಪಿ



International Patient Care
ಇಂಟರ್ನಾಷನಲ್ ಪೇಷಂಟ್ ಕೇರ್



Waiting Area
ವೇಟಿಂಗ್ ಏರಿಯಾ

OPD SIGNAGES



Meditation Hall
ಮೆಡಿಟೇಶನ್ ಹಾಲ್



Prayer Room
ಪ್ರೇಯರ್ ರೂಮ್



Baby Care
ಬೇಬಿ ಕೇರ್



Feeding Room
ಫೀಡಿಂಗ್ ರೂಮ್



Pharmacy
ಫಾರ್ಮಸಿ



Adult Vaccination
ಅಡಲ್ಟ್ ವ್ಯಾಕ್ಸಿನೇಷನ್

OPD SIGNAGES



Cathlab
ಕ್ಯಾಥ್‌ಲಾಬ್



MRI
ಎಮ್ ಆರ್ ಐ



CT Scan
ಸಿ ಟಿ ಸ್ಕ್ಯಾನ್



CR Console
ಸಿ ಆರ್ ಕೌನ್ಸೋಲ್



Mammography
ಮಮೋಗ್ರಫಿ



X-Ray Room
ಎಕ್ಸ್ - ರೆ ರೂಮ್

OPD SIGNAGES



Ultrasound Scanning Room
ಅಲ್ಟ್ರಾಸೌಂಡ್ ಸ್ಕ್ಯಾನಿಂಗ್ ರೂಮ್



Cathlab Recovery
ಕ್ಯಾಥಲಾಬ್ ರಿಕವರಿ



Contouring Room
ಕಾಂಟೂರಿಂಗ್ ರೂಮ್



BMD
ಬಿ ಎಮ್ ಡಿ



Digital Radiography
ಡಿಜಿಟಲ್ ರೇಡಿಯೊ ಗ್ರಫಿ



TPS Room
ಟಿ ಪಿ ಎಸ್ ರೂಮ್

IP, OT & ICU SIGNAGES



Operation Theatre
ಅಪರೇಷನ್ ಥಿಯೇಟರ್



Equipment Room
ಇಕ್ವಿಪ್‌ಮೆಂಟ್ ರೂಮ್



Procedure Room
ಪ್ರೋಸೀಜರ್ ರೂಮ್



Plasma Machine Room
ಪ್ಲಾಸ್ಮಾ ಮಷೀನ್ ರೂಮ್



General Ward
ಜನರಲ್ ವಾರ್ಡ್



Medical Preparation Room
ಮೆಡಿಕಲ್ ಪ್ರಿಪರೇಷನ್ ರೂಮ್

IP, OT & ICU SIGNAGES



PICU

ಪಿ ಐ ಸಿ ಯು



CCU

ಸಿ ಸಿ ಯು



NICU

ಎನ್ ಐ ಸಿ ಯು



Neuro ICU

ನ್ಯೂರೋ ಐ ಸಿ ಯು



Transplant ICU

ಟ್ರಾನ್ಸ್‌ಪ್ಲಾಂಟ್ ಐ ಸಿ ಯು



Surgical ICU

ಸರ್ಜಿಕಲ್ ಐ ಸಿ ಯು

IP, OT & ICU SIGNAGES



HDU
ಹೆಡಿ ಉ



CTVS ICU
ಸಿ ಟಿ ವಿಸ್ ಐ ಸಿ ಯು



Medical ICU
ಮೆಡಿಕಲ್ ಐ ಸಿ ಯು



IP Pharmacy
ಐ ಪಿ ಫಾರ್ಮಸಿ



Staff Changing Room
ಸ್ಟಾಫ್ ಚೇಂಜಿಂಗ್ ರೂಮ್

IP, OT & ICU SIGNAGES

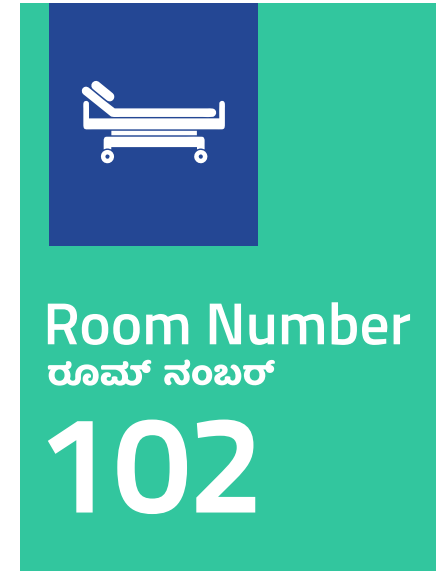

CSSD SIGNAGES



CSSD

సి ఎస్ ఎస్ డి



Cleaning Zone

క్లినింగ్ జోన్



Sterilization Zone

స్టెరిలైజేషన్ జోన్



Sterile Storage Area

స్టెరైల్ స్టోరేజ్ ఏరియా



Cleaning / Drying Area

క్లినింగ్ / డ్రైయింగ్ ఏరియా



Receiving Counter

రిసీవింగ్ కౌంటర్

CSSD SIGNAGES



Sterile Packs Issuing Counter
ಸ್ಟೆರೈಲ್ ಪ್ಯಾಕ್ಸ್ ಇಸ್ಯುಯಿಂಗ್ ಕೌಂಟರ್



Linen Store
ಲಿನೆನ್ ಸ್ಟೋರ್



Fresh Linen
ಫ್ರೆಶ್ ಲಿನೆನ್



Used Linen
ಯುಸ್ಡ್ ಲಿನೆನ್

HOUSEKEEPING SIGNAGES



Clean Utility
ಕ್ಲೀನ್ ಯುಟಿಲಿಟಿ



Dirty Utility
ಡರ್ಟಿ ಯುಟಿಲಿಟಿ



Hot Surface
ಹಾಟ್ ಸರ್ಫೇಸ್



Trolley Washroom
ಟ್ರೋಲಿ ವಾಶ್ರೂಮ್



Biomedical Waste
ಬಯೋಮೆಡಿಕಲ್ ವೇಸ್ಟ್



Dry Waste
ಡ್ರೈ ವೇಸ್ಟ್

RESTROOM SIGNAGES



CAFETERIA SIGNAGES



Kitchen

ಕಿಚನ್



Veg Cafeteria

ವೆಜ್ ಕೆಫೆಟೀರಿಯಾ



Non-Veg Cafeteria

ನಾನ್ ವೆಜ್ ಕೆಫೆಟೀರಿಯಾ



Executive Cafe

ಎಕ್ಸಿಕ್ಯೂಟಿವ್ ಕೆಫೆ



Doctors Dining

ಡಾಕ್ಟರ್ಸ್ ಡೈನಿಂಗ್



RO Water

ಆರ್ ಓ ವಾಟರ್

CAFETERIA SIGNAGES



Outside Food Not Allowed

ಬೆಟ್ ಸೈಡ್ ಫುಡ್ ನಾಟ್ ಅಲೋವ್ಡ್



Dishwashing Area

ಡಿಶ್ವಾಶಿಂಗ್ ಏರಿಯಾ



Hand Wash

ಹ್ಯಾಂಡ್ ವಾಶ್



Wet Waste

ವೆಟ್ ವೇಸ್ಟ್

FACILITY SIGNAGES



Fire Control Room

ಫೈರ್ ಕಂಟ್ರೋಲ್ ರೂಮ್



Electrical Room

ಎಲೆಕ್ಟ್ರಿಕಲ್ ರೂಮ್



Manifold Room

ಮ್ಯಾನಿಫೋಲ್ಡ್ ರೂಮ್



TFA

ಟಿ ಫ್ ಎ



AHU Room

ಎ ಹೆಚ್ ಯು ರೂಮ್



UPS Room

ಯು ಪಿ ಎಸ್ ರೂಮ್

FACILITY SIGNAGES



CCTV Room
ಸಿ ಸಿ ಟಿ ವಿ ರೂಮ್



EPABX Room
ಇ ಪಿ ಎ ಬಿ ಎಕ್ಸ್ ರೂಮ್



EO Gas Room
ಇವೋ ಗ್ಯಾಸ್ ರೂಮ್



ATM
ಎ ಟಿ ಎಮ್



Restricted Access
ರೆಸ್ಟ್ರಿಕ್ಡ್ ಎಕ್ಸೆಸ್



Caution
ಕಾಷನ್

FACILITY SIGNAGES



Compressor Room
ಕಂಪ್ರೆಸರ್ ರೂಮ್



Biohazard
ಬಯೋಹಾಜರ್ಡ್



Mortuary
ಮೊರ್ಟ್ವರಿ



You are under CCTV Surveillance
ನೀವು ಸಿಸಿಟಿವಿ ಕಣ್ಗಾವಲಿನಲ್ಲಿರುತ್ತೀರಿ

FACILITY SIGNAGES

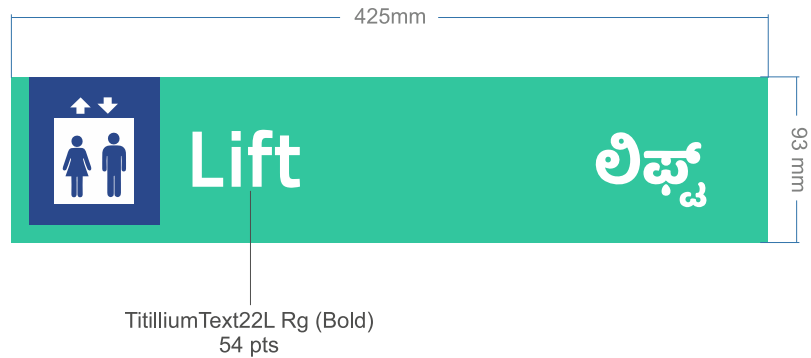
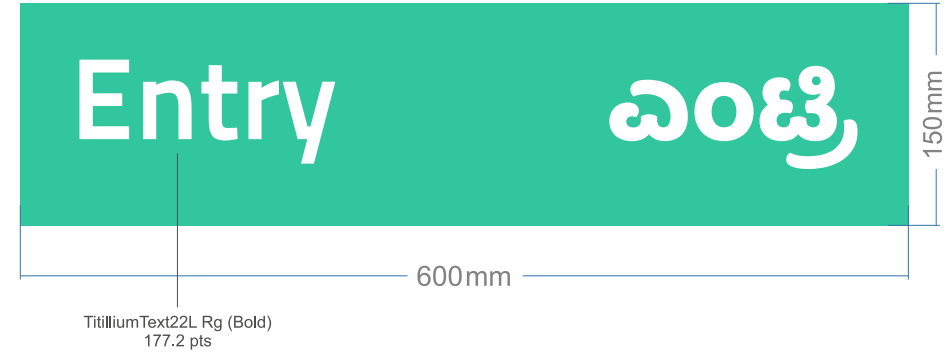
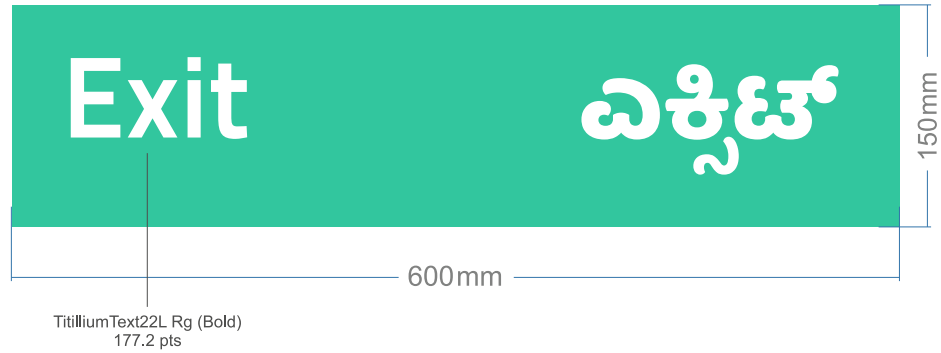

RADIOLOGY SIGNAGES

A3

Notice

Sex Determination of foetus is not done here.
it is a punishable offence under
PC & PNDT Act.1994

Asking for Sex Determination of foetus is also
offence under PC & PNDT Act.1994"

ದಯವಿಟ್ಟು ಗಮನಿಸಿ.

ಭ್ರೂಣದ ಲಿಂಗ ನಿರ್ಣಯವನ್ನು ಇಲ್ಲಿ ಮಾಡಲಾಗುವುದಿಲ್ಲ; ಇದು
ಪಿಸಿ ಆಂಡ್ ಪಿಎನ್‌ಡಿ ಕಾಯಿದೆ 1994 ಪ್ರಕಾರ ಶಿಕ್ಷಾರ್ಹ ಅಪರಾಧವಾಗಿದೆ.

ಭ್ರೂಣದ ಲಿಂಗ ನಿರ್ಣಯವನ್ನು ಕೇಳುವುದು ಸಹ ಅಪರಾಧವಾಗಿದೆ
ಇದು ಕೂಡ ಪಿಸಿ ಆಂಡ್ ಪಿಎನ್‌ಡಿ ಕಾಯಿದೆ 1994 ಪ್ರಕಾರ
ಶಿಕ್ಷಾರ್ಹ ಅಪರಾಧವಾಗಿದೆ.

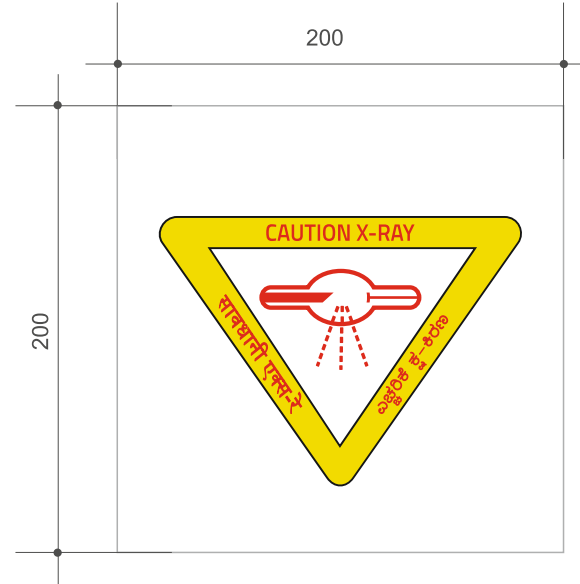

Specification:
Eco Solvent print on vinyl mounted on 5mm Sunboard

ADMINISTRATIVE OFFICE SIGNAGES



Chief Executive Officer

ಚೀಫ್ ಎಸ್‌ಎಕ್ಯೂಟಿವ್ ಆಫೀಸರ್



Chief Operating Officer

ಚೀಫ್ ಆಪರೇಟಿಂಗ್ ಆಫೀಸರ್



Administrative Office

ಅಡ್ಮಿನಿಸ್ಟ್ರೇಟಿವ್ ಆಫೀಸ್



Chief Medical Superintendent

ಚೀಫ್ ಮೆಡಿಕಲ್ ಸುಪರಿಂಟೆಂಡೆಂಟ್



Medical Records Department

ಮೆಡಿಕಲ್ ರೆಕಾರ್ಡ್ಸ್ ಡಿಪಾರ್ಟ್‌ಮೆಂಟ್



Engineering

ಇಂಜಿನಿಯರಿಂಗ್

ADMINISTRATIVE OFFICE SIGNAGES



*In finance department the currency icon can be updated as per the mode of currency used in your respective countries.

ADMINISTRATIVE OFFICE SIGNAGES



Supply Chain Management
ಸಪ್ಲೈ ಚೈನ್ ಮ್ಯಾನೇಜ್‌ಮೆಂಟ್



Quality
ಕ್ವಾಲಿಟಿ



Housekeeping
ಹೌಸ್ ಕೀಪಿಂಗ್



Library
ಲೈಬ್ರರಿ



Store Room
ಸ್ಟೋರ್ ರೂಮ್



Support Service Department
ಸಪೋರ್ಟ್ ಸರ್ವಿಸ್ ಡಿಪಾರ್ಟ್‌ಮೆಂಟ್

ADMINISTRATIVE OFFICE SIGNAGES



HUB Room
ಹಬ್ ರೂಮ್



Training Room
ಟ್ರೈನಿಂಗ್ ರೂಮ್



Console
ಕೌನ್ಸೋಲ್



Conference Room
ಕಾನ್ಫರೆನ್ಸ್ ರೂಮ್

FIRE SAFETY SIGNAGES

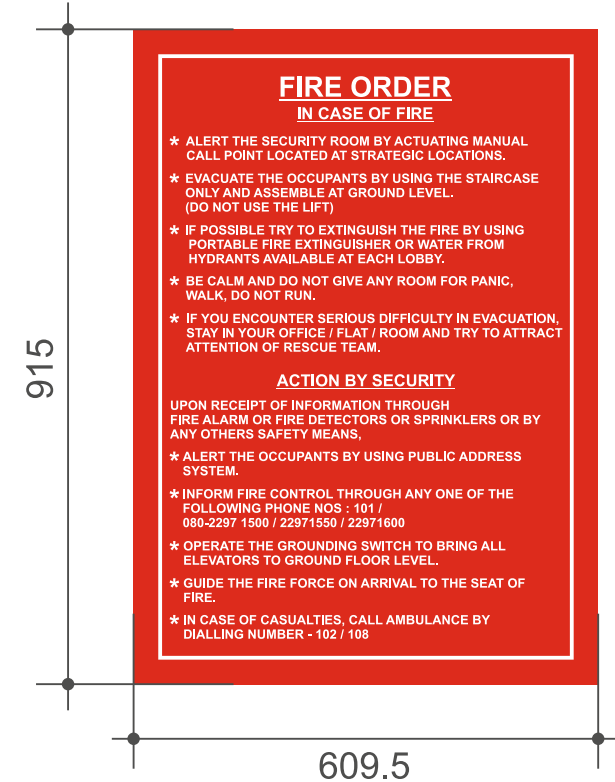

Specification:
5mm Sunboard with night glow and reflective vinyl

FIRE SAFETY SIGNAGES

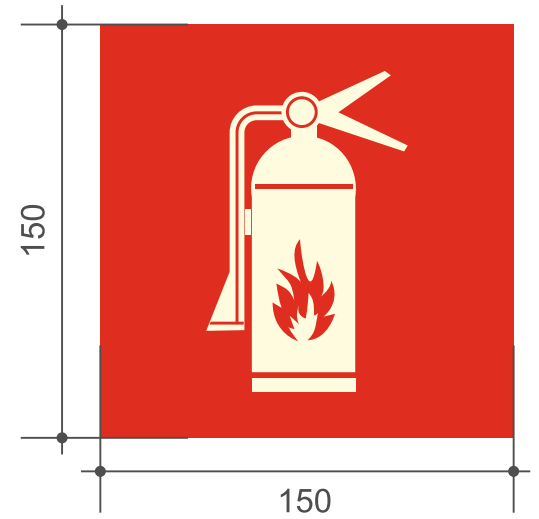
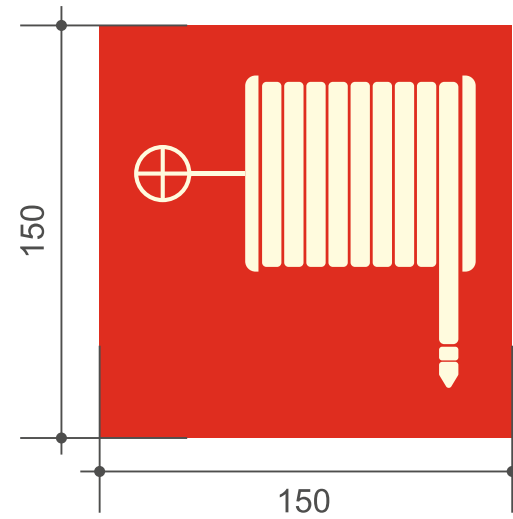
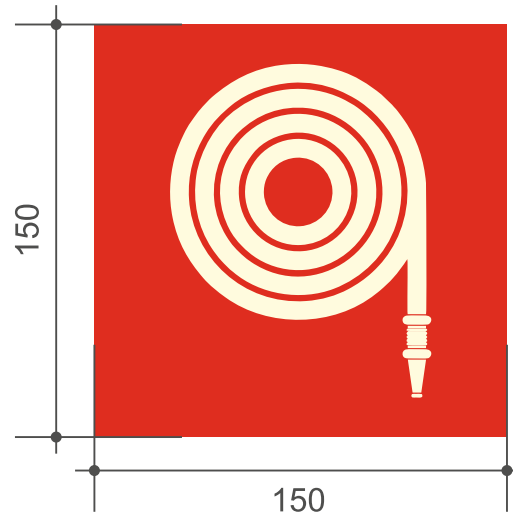
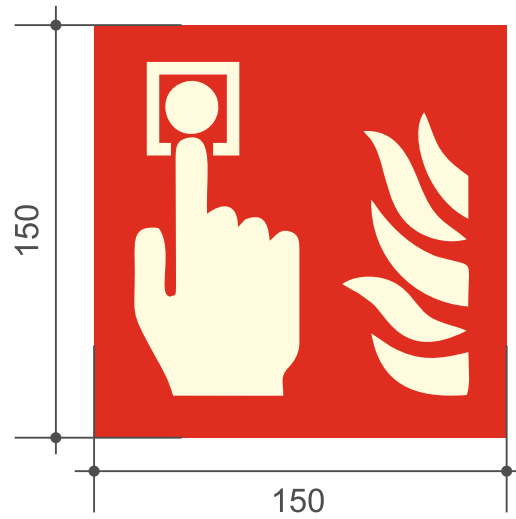

Specification:
5mm Sunboard with night glow and reflective vinyl

THANK YOU

Aster Clinic Brand Guidelines

What's the point of guidelines?

They're the vitamin dose for your brand's health!



CONTENTS

BRAND

Promise - Tagline & Tagline Usage 04

IDENTITY

Clear Space 05

Ribbon Logo 06

Ribbon Logo Ratios 07

Stacked Logo - Clear Space, Minimum Size 08

Extended Logo - Clear Space, Minimum Size 09

BRAND LANGUAGE

Colors 10

Typography - English 11

Typography - Arabic 12

STATIONERY

Business Card 13

Letterhead 14

Envelope A4 & A5 15

Envelope DL 16

Folder A4 17

CD Sticker & Sleeve 18

PPT Template 19

Name Tag 20

ID Card 21

Forms - Registration Form, Lab Requisition Form 22

Prescription Pad 23

PRINT COMMS

Print AD 24

OUTDOOR

Billboard 25

SIGNAGE

Signage Ribbon Logo Ratio 26

Vertical Signage 27

Internal Directory & Signage 28

Directory Department Icons 29

Reception Signage Ratio 30

External Signage Specs 31

Internal Signage Specification 32

Reception Signage Specification 33

ACCESSORIES

Clock 34

Cap 35

VEHICLE BRANDING

36

BRAND PROMISE

TAGLINE & TAGLINE USAGE



IDENTITY

CLEAR SPACE

GRID GUIDELINE 1



GRID GUIDELINE 2



GRID GUIDELINE 3



IDENTITY

RIBBON LOGO

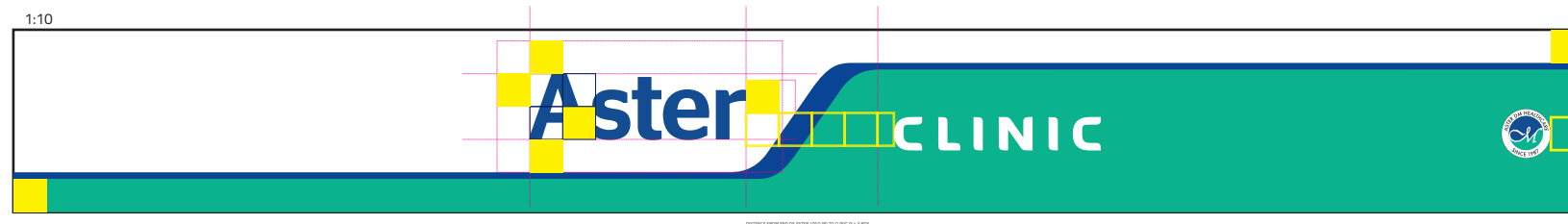
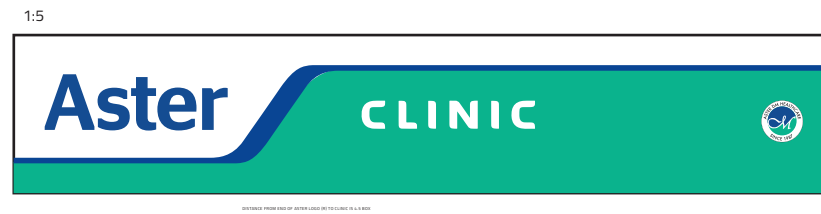

IDENTITY

RIBBON LOGO RATIOS



IDENTITY

STACKED LOGO



STACKED LOGO CLEAR SPACE



STACKED LOGO MINIMUM SIZE



IDENTITY
EXTENDED LOGO







EXTENDED LOGO CLEAR SPACE



EXTENDED LOGO MINIMUM SIZE

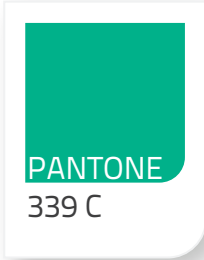

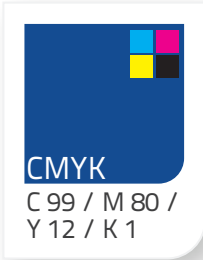
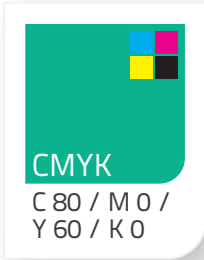
CORPORATE BRAND COLORS

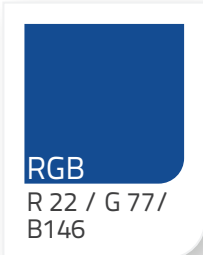
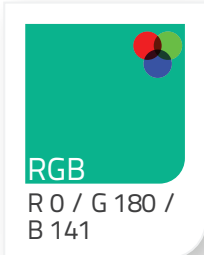
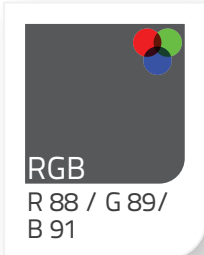
	COLOR	SECONDARY COLOR	SECONDARY COLOR
PANTONE	 <p>PANTONE 7687 C</p>	 <p>PANTONE 339 C</p>	 <p>PANTONE 425 C</p>
C M Y K	 <p>CMYK C 99 / M 80 / Y 12 / K 1</p>	 <p>CMYK C 80 / M 0 / Y 60 / K 0</p>	 <p>CMYK C 0 / M 0 / Y 0 / K 80</p>
WEB/DIGITAL	 <p>RGB R 22 / G 77 / B 146</p>	 <p>RGB R 0 / G 180 / B 141</p>	 <p>RGB R 88 / G 89 / B 91</p>

CORPORATE TYPOGRAPHY

ENGLISH

TitillumText22L Thin

ABCDEFGHIJKLMNOPQRSTUVWXYZ
abcdefghijklmnopqrstuvwxyz

TitillumText22L Regular

ABCDEFGHIJKLMNOPQRSTUVWXYZ
abcdefghijklmnopqrstuvwxyz

TitillumText22L Bold

ABCDEFGHIJKLMNOPQRSTUVWXYZ
abcdefghijklmnopqrstuvwxyz

TitillumText22L XBold

ABCDEFGHIJKLMNOPQRSTUVWXYZ
abcdefghijklmnopqrstuvwxyz

CORPORATE TYPOGRAPHY

ARABIC

GE Dinar One - Light

ا ب ت ث ج ح خ د ذ ر ز س ش ص ض ط ظ ع غ ف ق ك ل م ن ه و ي

GE Dinar One - Light Italic

ا ب ت ث ج ح خ د ذ ر ز س ش ص ض ط ظ ع غ ف ق ك ل م ن ه و ي

GE Dinar One - Regular

ا ب ت ث ج ح خ د ذ ر ز س ش ص ض ط ظ ع غ ف ق ك ل م ن ه و ي

GE Dinar One - Medium

ا ب ت ث ج ح خ د ذ ر ز س ش ص ض ط ظ ع غ ف ق ك ل م ن ه و ي

GE Dinar One - Medium Italic

ا ب ت ث ج ح خ د ذ ر ز س ش ص ض ط ظ ع غ ف ق ك ل م ن ه و ي

GE Dinar One - Bold

ا ب ت ث ج ح خ د ذ ر ز س ش ص ض ط ظ ع غ ف ق ك ل م ن ه و ي

GE Dinar One - Black

ا ب ت ث ج ح خ د ذ ر ز س ش ص ض ط ظ ع غ ف ق ك ل م ن ه و ي

STATIONERY BUSINESS CARD

Business Card
Size : 9.01 cm X 5.51 cm

Material Specification
300GSM Linen Half White
Texture Board



Aster
CLINIC

We'll Treat You Well



Aster Clinic - Place
Address
Address
P.O. Box : 8703
Dubai - U.A.E
T : + 971 0 000 0000
Helpline + 971 4 400 500
www.asterclinic.ae

First Name Last Name
Designation - Department
M : + 971 00 000 0000
E : name@website.com

STATIONERY LETTERHEAD

Letterhead
Size : 210 cm X 297 cm

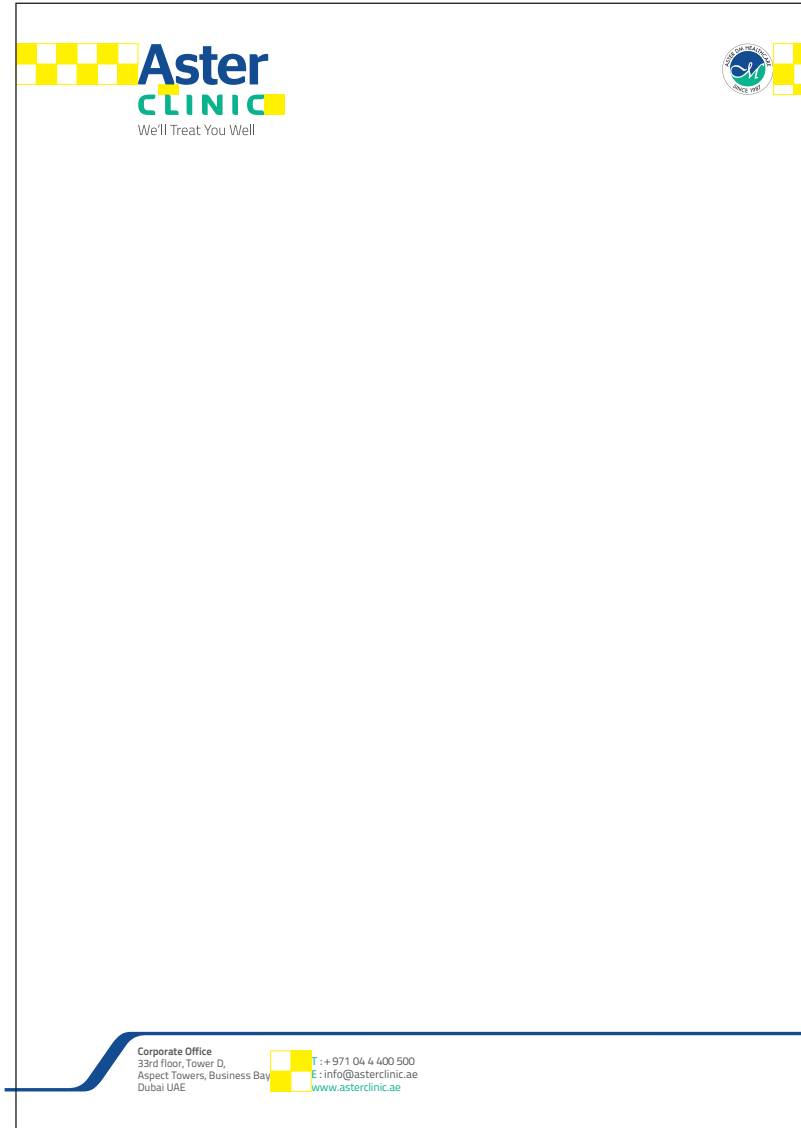

STATIONERY

ENVELOPE A4 & A5

Envelope A4 Size
32.4cm X 23.5cm

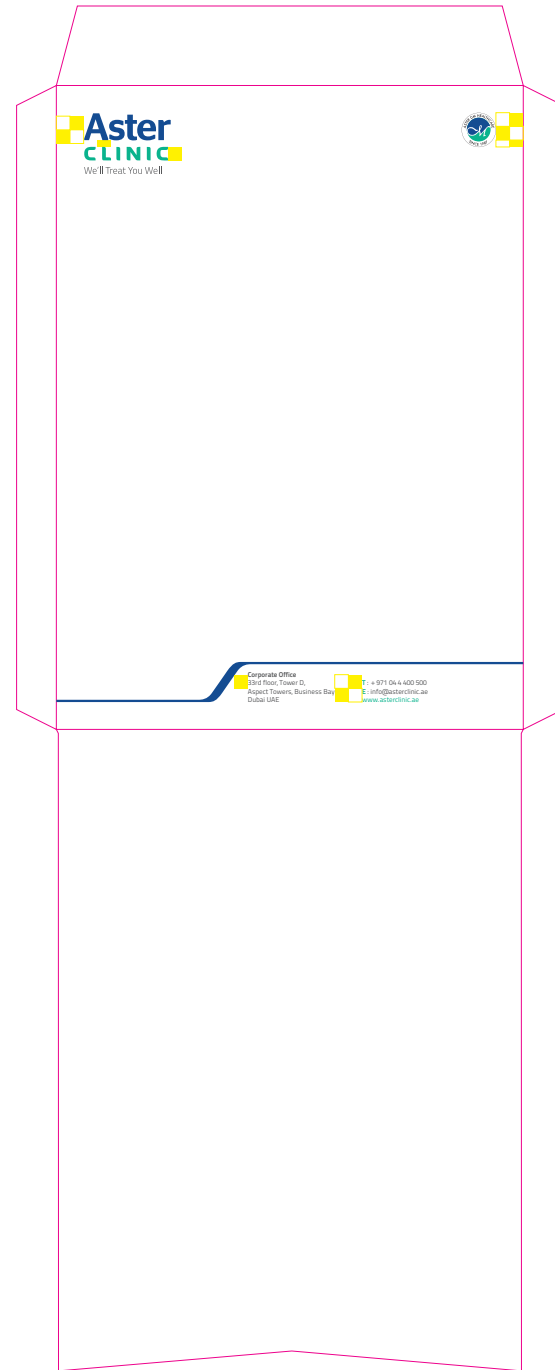

Envelope A5 Size
22cm X 15.85 cm



STATIONERY ENVELOPE DL

Envelope - Aster Clinic
DL Size 22cm X 11cm



STATIONERY FOLDER A4

A4 Folder - Aster Clinic
Size 45.5 cm X 30.5 cm

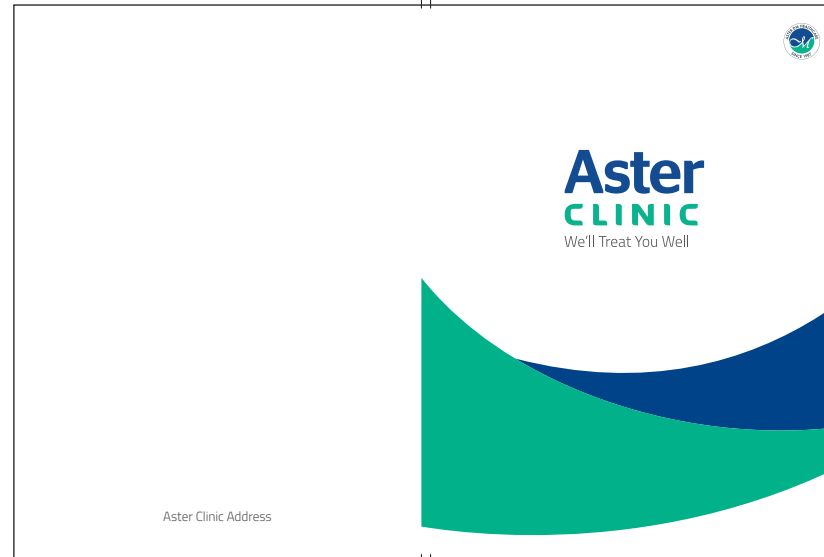

STATIONERY

CD STICKER & SLEEVE

CD label



CD cover

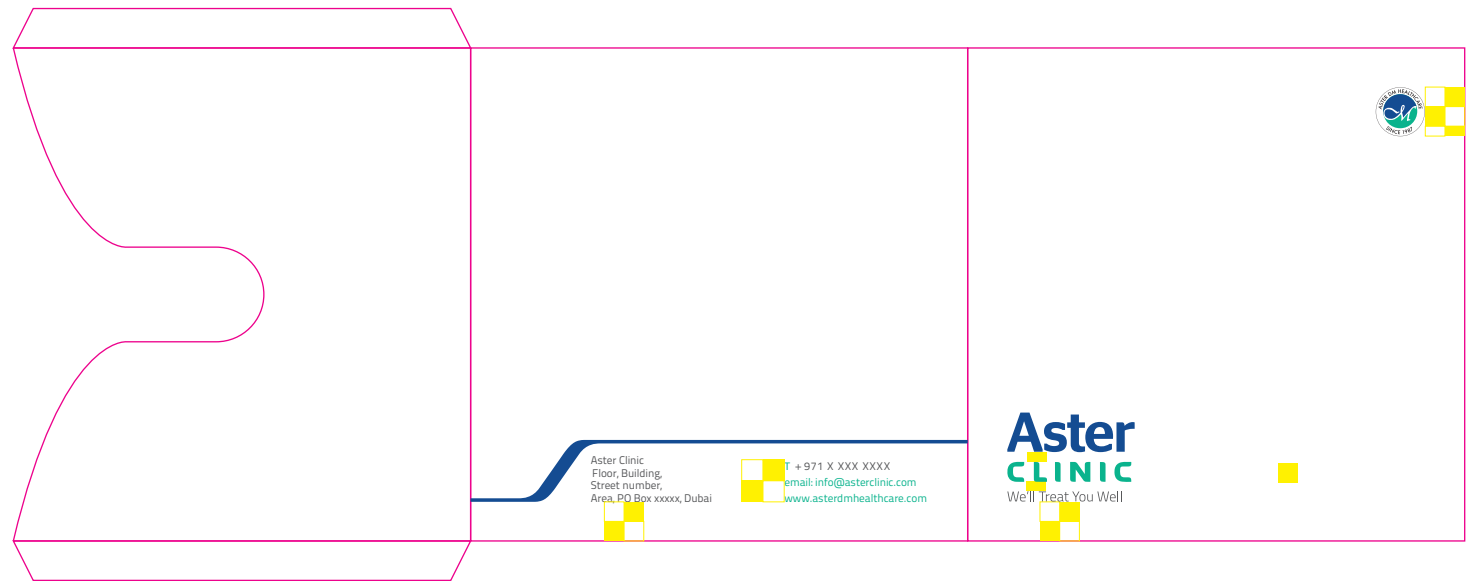

STATIONERY

PPT TEMPLATE

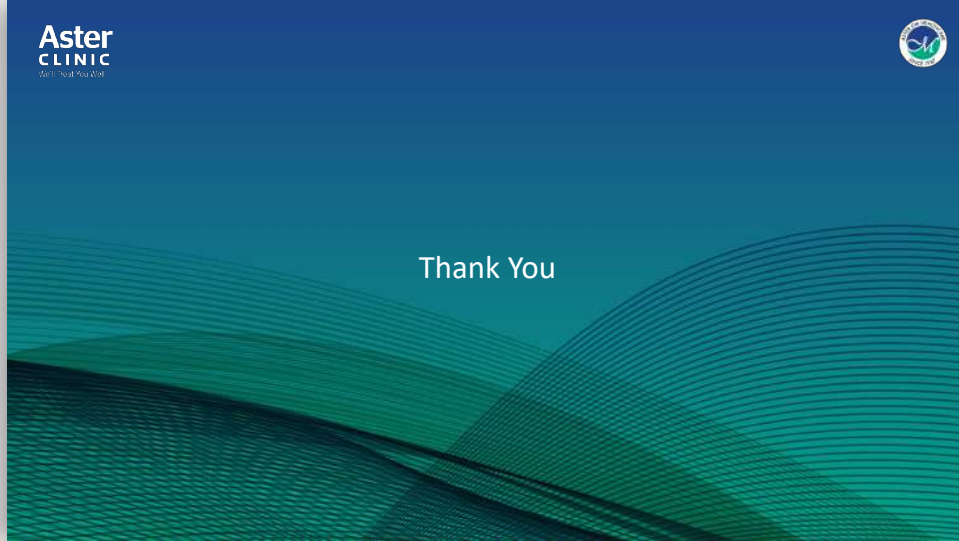

STATIONERY NAME TAG

NAME LAST NAME

Department Name

Aster CLINIC



NAME LAST NAME

Department Name

Aster CLINIC



STATIONERY

ID CARD

ID Card
Size : 5.5019 cm X 9.2 cm

Front



Back

STATIONERY FORMS

REGISTRATION FORM



REGISTRATION FORM
Please write legibly in **BLOCK** letters



Name _____

Date of Birth _____ Gender M F

Nationality _____ Marital Status _____

Occupation _____

Mobile No. _____ Office Phone _____

Landline (Home) _____ P.O. Box _____

email: _____

Please fill the details any of the following

1. Passport No. _____ 2. Emirates ID _____

3. Labour Card _____ 4. Driving License _____

5. Insurance Card _____

Emergency contact person details

Name _____ Mobile _____

Relationship _____ email _____

Payment details

Self Insurance Company _____ Policy No. _____

Employer _____

Phone No. _____ Others (Specify) _____

Have you visited Aster Clinic before Yes No



For office use only

MR No. _____ Date _____

Registered by _____ Department _____

We'll Treat You Well

LAB REQUISITION FORM

LABORATORY / RADIOLOGY REQUISITION FORM

Name		
Reg. No.	Gender	Date
D.O.B. / Age	Ref. by Dr.	
Clinic / Hospital Name		
Payment <input type="checkbox"/> Cash <input type="checkbox"/> Credit		

Investigation Required

Brief Clinical History

URGENT / ROUTINE	Name	Sign & Stamp
For Departmental Use		Time
Sample Collected by		
Sample Bar Code Generated by		
Test Performed by		
Report Signed by		

Aster Medinova Diagnostic Centre
Khalid Bin Al Waleed Road,
Near Al Fahidi Metro Station
Bur Dubai. P.O. Box 26167

T +971 4 5090 400 / 402
Helpline 04 4 400 500
email: medinova@asterclinic.ae
www.asterclinic.ae

We'll Treat You Well

STATIONERY PRESCRIPTION PAD

Aster
CLINIC



Name Reg. No.

Age Gender Date

R_x

OUTPATIENT CARE FACILITY - POLYCLINIC DO NOT SUBSTITUTE MEDICINE

Al Khawanej First,
Ahamed Dhafer Real Estate Building,
P.O. Box 8703, Dubai - UAE.
A unit of Aster DM Healthcare

T +971 4 4546001
Helpline 04 4 400 500
email: feedback@asterclinic.ae
www.asterclinic.ae

We'll Treat You Well

PRINT COMMS

PRINT AD

Vertical
Size : 225.09mm x 297.09mm



**Aster
CLINIC**
We'll Treat You Well



IMAGE SPACE

LOREM IPSUM DOLOR

Lorem ipsum dolor sit amet, consectetur adipiscing elit, sed do eiusmod tempor incididunt ut labore et dolore magna aliqua. Ut enim ad minim veniam, quis nostrud exercitation ullamco laboris nisi ut aliquip ex ea commodo consequat. Duis aute irure dolor in reprehenderit in voluptate velit esse cillum dolore eu fugiat nulla pariatur. Excepteur sint occaecat cupidatat non proident, sunt in culpa qui officia deserunt mollit anim id est laborum.

Lorem ipsum dolor sit amet, consectetur | Adipiscing elit, sed do eiusmod tempor | Lncididunt ut labore et dolore magna aliqua | Ut enim ad minim veniam | Qis nostrud exercitation | Llamco laboris nisi ut aliquip ex ea | Commodo consequat | Duis aute irure dolor in reprehenderit | Voluptate | Adipiscing elit, sed do eiusmod tempor | Lncididunt ut labore et dolore magna aliqua | Ut enim ad minim veniam
 Lorem ipsum dolor sit amet, consectetur.

WWW.ASTERCLINIC.COM | 800900800

Horizontal
Size : 297.09mm x 225.09mm



**Aster
CLINIC**
We'll Treat You Well



IMAGE SPACE

LOREM IPSUM DOLOR

Lorem ipsum dolor sit amet, consectetur adipiscing elit, sed do eiusmod tempor incididunt ut labore et dolore magna aliqua. Ut enim ad minim veniam, quis nostrud exercitation ullamco laboris nisi ut aliquip ex ea commodo consequat. Duis aute irure dolor in reprehenderit in voluptate velit esse cillum dolore eu fugiat nulla pariatur. Excepteur sint occaecat cupidatat non proident, sunt in culpa qui officia deserunt mollit anim id est laborum.

Lorem ipsum dolor sit amet, consectetur | Adipiscing elit, sed do eiusmod tempor | Lncididunt ut labore et dolore magna aliqua | Ut enim ad minim veniam | Qis nostrud exercitation | Llamco laboris nisi ut aliquip ex ea | Commodo consequat | Duis aute irure dolor in reprehenderit | Voluptate | Adipiscing elit, sed do eiusmod tempor | Lncididunt ut labore et dolore magna aliqua | Ut enim ad minim veniam
 Lorem ipsum dolor sit amet, consectetur.

WWW.ASTERCLINIC.COM | 00-0000-0000

OUTDOOR BILLBOARD

Vertical
Size: 204.5 mm x 241mm

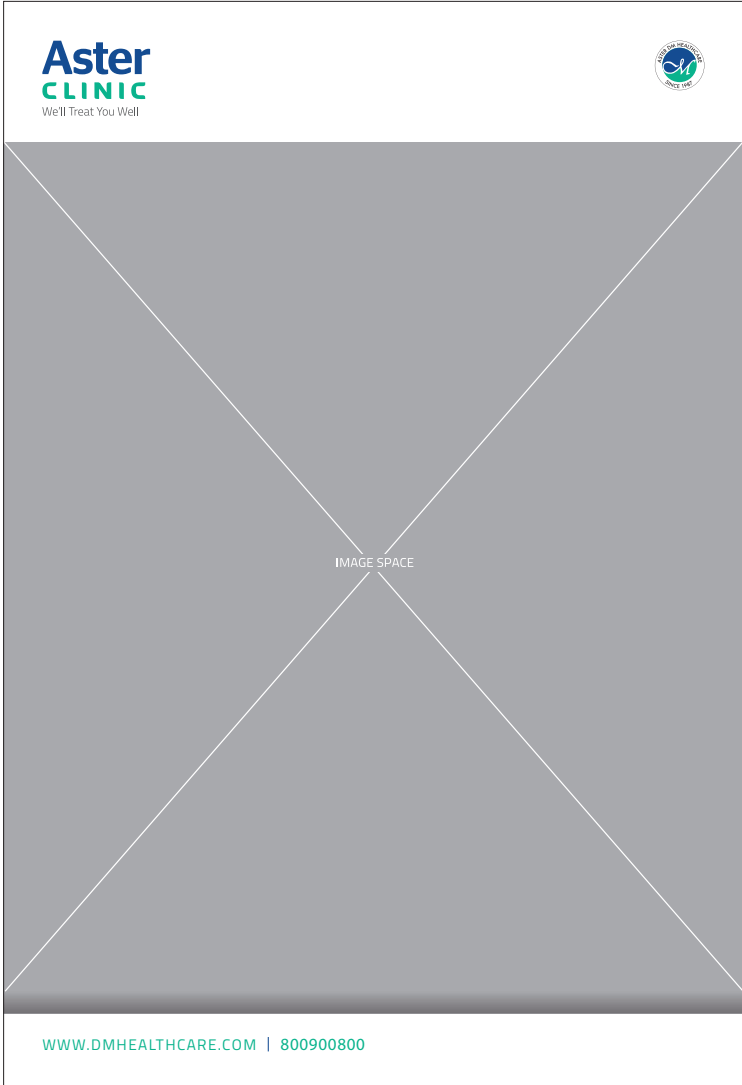

Horizontal
Size : 150mm x 60mm

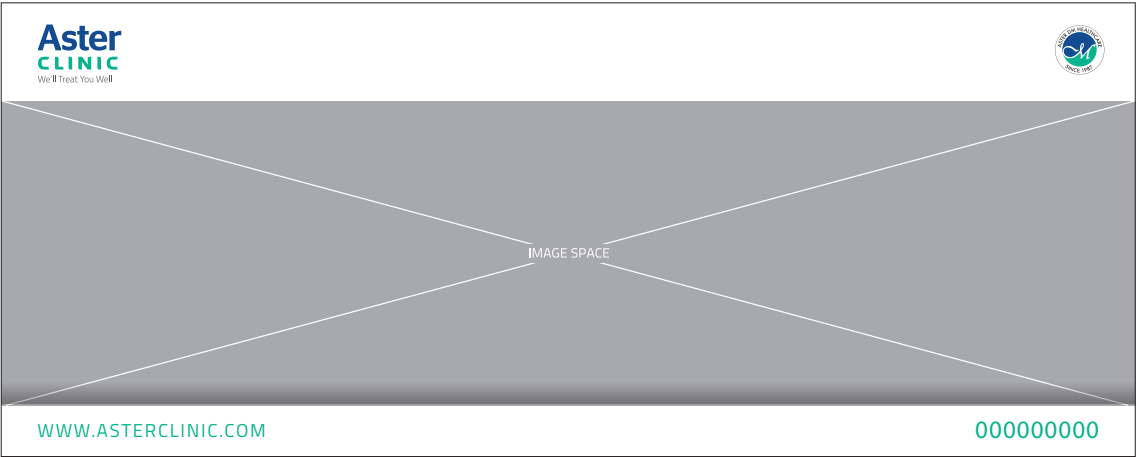

SIGNAGE

SIGNAGE RIBBON LOGO RATIO



SIGNAGE

VERTICAL SIGNAGE

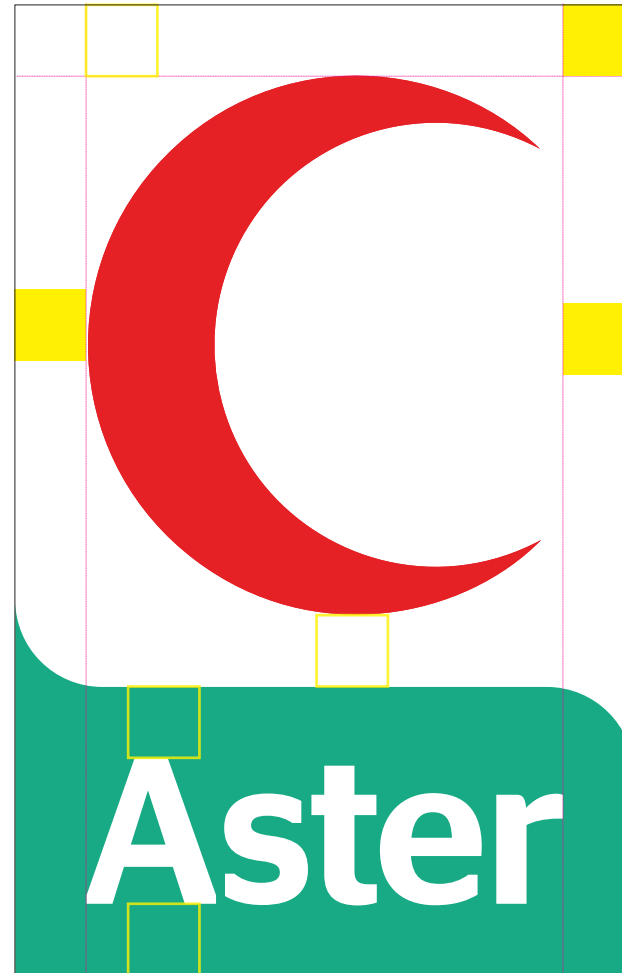

SIGNAGE

INTERNAL DIRECTORY & SIGNAGE

Aster

CLINIC

GENERAL MEDICINE

Local Lanuage

Dr. Abdel Raouf

MBBS, MD (Specialist Family Medicine)

GENERAL PRACTITIONER

Local Lanuage

Dr. Basir Sajjad Bhat

MBBS, (General Practitioner)

Direction Signage



Door Sign

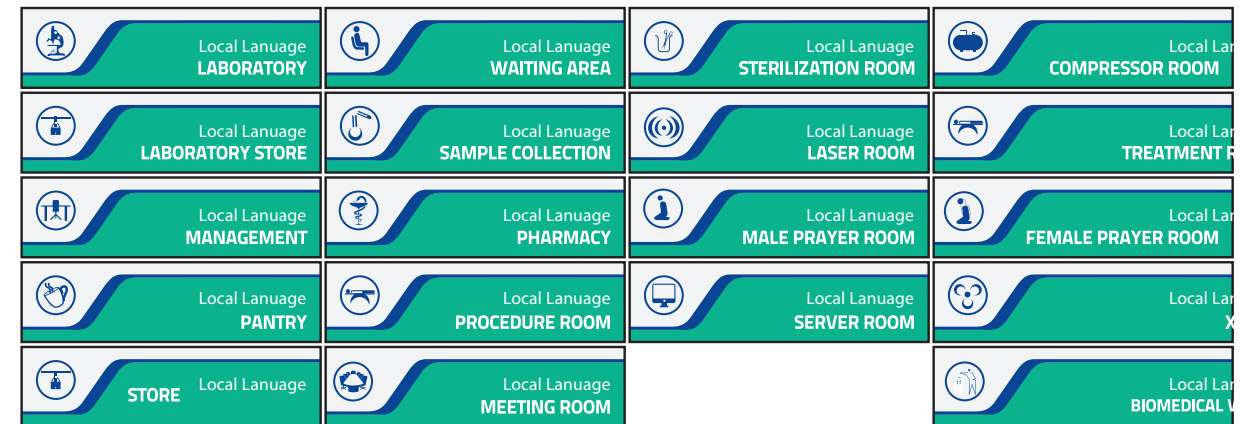











Doctor Door



SIGNAGE

DIRECTORY DEPARTMENT ICONS

 DENTAL طب الأسنان	 RADIOLOGY الأشعة	 PULMONOLOGY أمراض الرئة
 DERMATOLOGY الجلدية و التناسلية	 UROLOGY الجهاز البولي	 NEPHROLOGY أخصائي أمراض الكلى
 DIABETOLOGY & ENDOCRINOLOGY السكر و الغدد الصماء	 ORTHOPEDIC SURGERY جراحة العظام	 NEUROLOGY علم الأعصاب
 ENT الأنف الأذن والحنجرة	 AUDIOLOGY أمراض السمع	 OBS & GYNAECOLOGY النساء و الولادة
 GASTROENTEROLOGY علم المعدة و الأمعاء	 DIET & NUTRITION الحمية و التغذية	 OPHTHALMOLOGY طب العيون
 GENERAL MEDICINE الطب العام	 ORTHOPAEDICS علم العظام	 PATHOLOGY المختبر
 GENERAL SURGERY الجراحة العامة	 CARDIOLOGY القلب	 PAEDIATRICS طب الأطفال
 INTERNAL MEDICINE الطب الباطني	 PSYCHIATRY طب نفسي	 PHYSIOTHERAPY غرفة العلاج الطبيعي

SIGNAGE

RECEPTION SIGNAGE RATIO



SIGNAGE

EXTERNAL SIGNAGE SPECS

SIGNAGE DETAILS

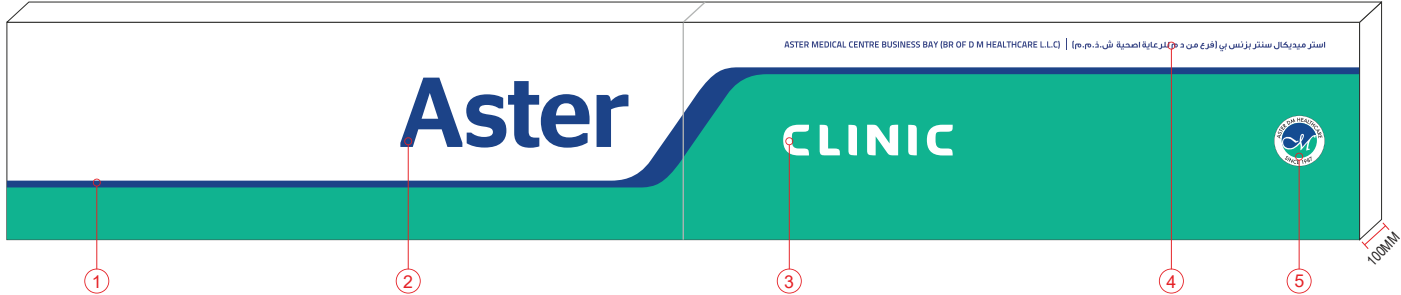

① 3MM THICK ALUMINUM SHEET IN PAINTED FINISH

COLOR REF:

□ WHITE POWDER COAT RAL 9003

■ PAINT TO MATCH PANTONE 7687 C

■ PAINT TO MATCH PANTONE 339 C

② 40MM 3D EMBOSSED ACRYLIC LETTERS (ACRYLIC COLOR REF: MODEN GLAS M327 BLUE CAST ACRYLIC) SIDE RETURNS IN PAINT FINISH TO MATCH PANTONE 7687 C FACE LIT LETTERS (6000K LED STRIPS)

③ 40MM 3D EMBOSSED OPAL WHITE ACRYLIC LETTERS. SIDE RETURNS IN WHITE PAINT FINISH. FACE LIT LETTERS (6000K LED STRIPS)

④ 3MM THICK ACRYLIC CUT LETTERS (ACRYLIC COLOR REF: MODEN GLAS M327 BLUE CAST ACRYLIC)

⑤ 40MM 3D EMBOSSED OPAL WHITE ACRYLIC LOGO WITH VINYL FASCIA. SIDE RETURNS IN WHITE PAINT FINISH. FACE LIT LOGO (6000K LED STRIPS)

COLOR REF:

■ "AVERY 450-02M" VINYL

■ "AVERY 4517 TF DARK BLUE" (REF. 375623) VINYL

■ "AVERY 4539 TF TURQUOISE" (REF. 370355) VINYL

STRUCTURAL DETAILS

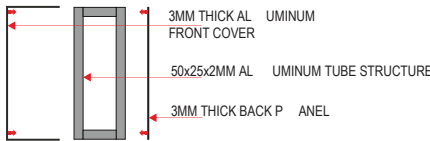
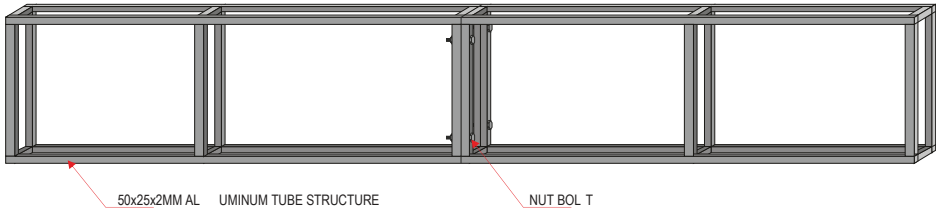

LETTER DETAILS

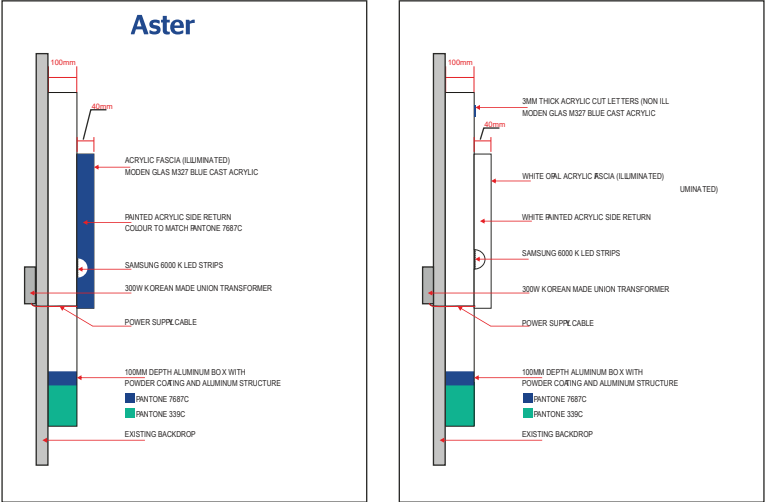

SIGNAGE DETAILS

10MM CLEAR ACRYLIC SHEET IN WHITE PAINT FINISH WITH VINYL STICKER
DOUBLE SIDED

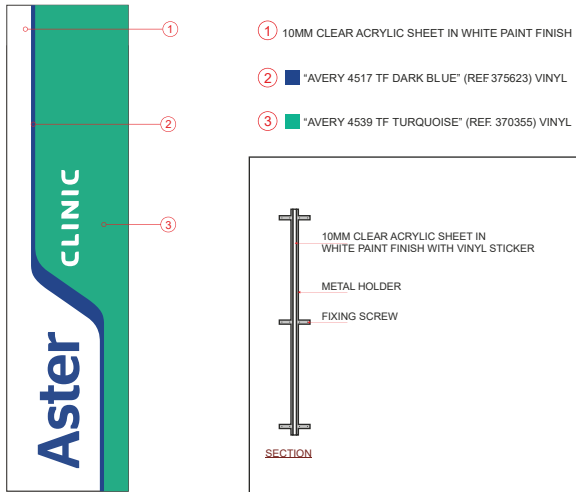

SIGNAGE

INTERNAL SIGNAGE SPECIFICATION

Door Sign

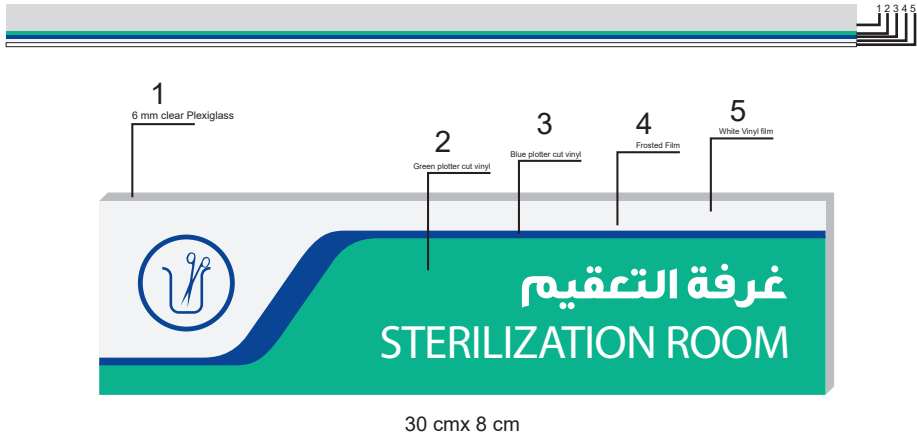

* The vinyl & Frosted sticker is fixed reverse on Plexi glass.

Hanging Sign



* The vinyl & Frosted sticker is fixed reverse on Plexi glass.

Doctors Door Sign

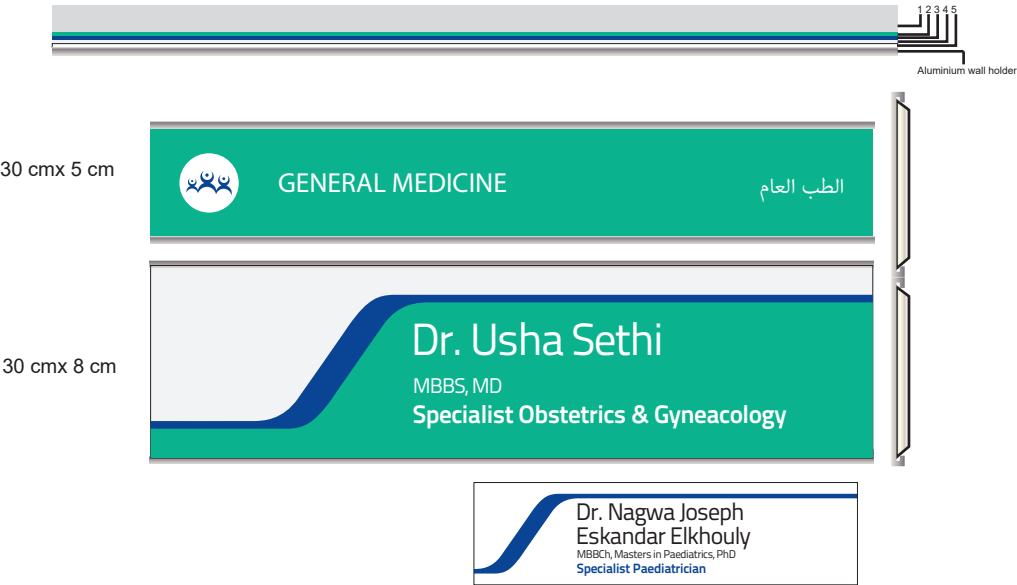

Directory Sign

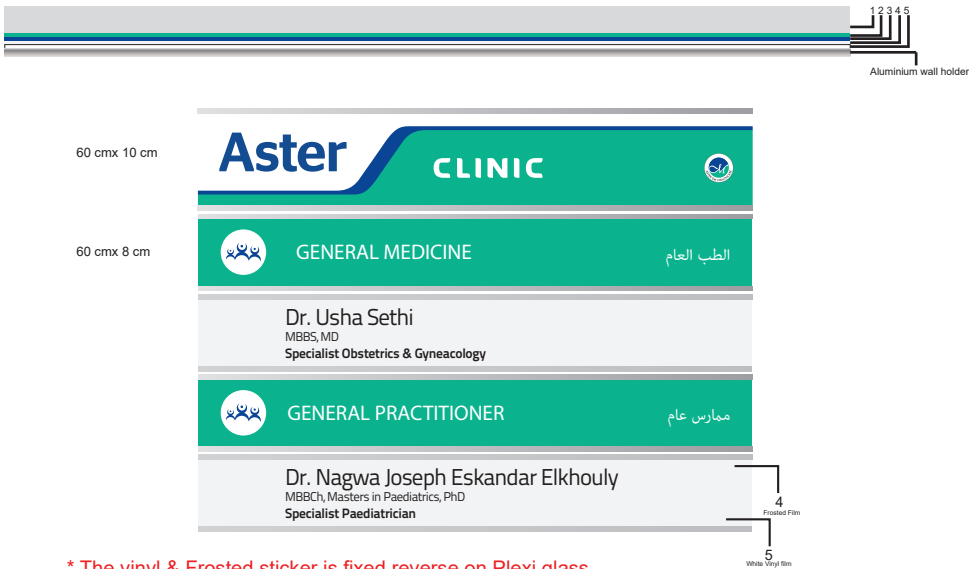

* The vinyl & Frosted sticker is fixed reverse on Plexi glass.

SIGNAGE

RECEPTION SIGNAGE SPECIFICATION

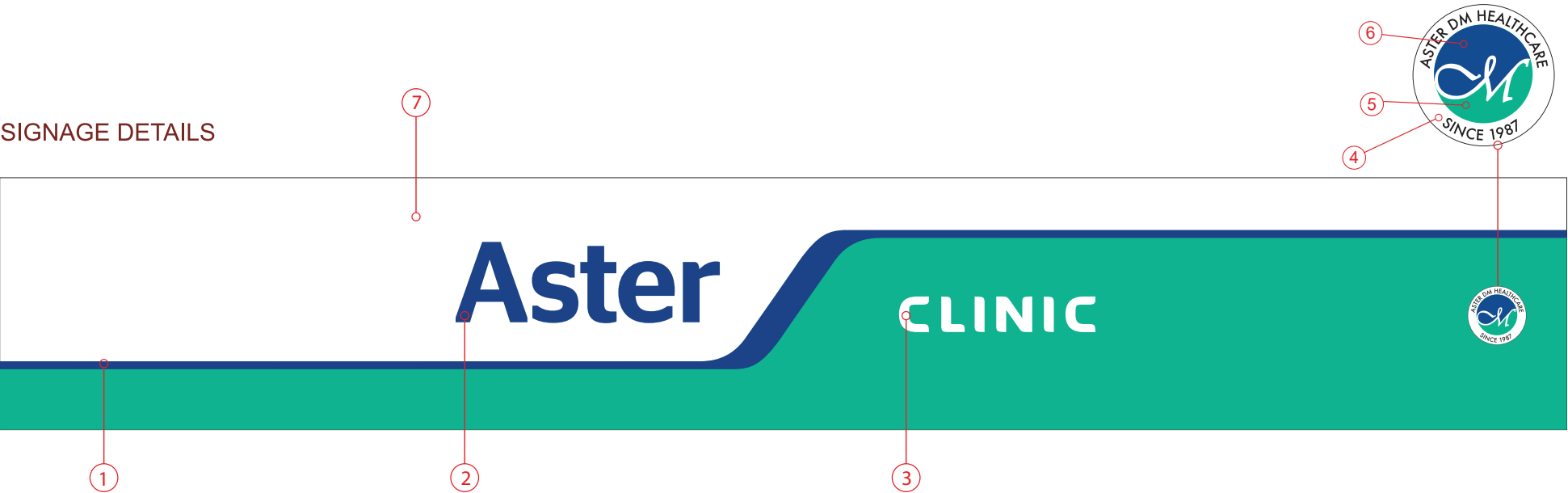

SIGNAGE DETAILS

COLOR REF

- Opaque white acrylic - code No - 402
- MACal ULTRAMARINEBLUE -Ref# M823803 -MTR "
- OR
- Avery 4517 tf dark blue (ref: 375623)**
- "A VERY 4539 TF TURQUOISE" (REF . 370355) VINYL

- 1** Plotter cut vinyl sticker
- 2** 8mm clear laser cut acrylic letters with ultramarine vinyl sticker fixed on to the 4mm opaque white base.
- 3** 8mm Opaque white laser cut acrylic fixed on to the 4mm opaque white base
- 4** Laser cut 8mm opaque White acrylic (402) with UV print or graphic printed on vinyl and pasting on opaque white acrylic
- 5** Plotter cut- Green vinyl ref avery 4539 tf turquoise (ref: 370355)
- 6** Plotter cut- Blue vinyl ref avery 4517 tf dark blue (ref: 375623)
- 7** 4mm opaque white base

ACCESSORIES

CLOCK



ACCESSORIES

CAP



VEHICLE LIVERY VEHICLE BRANDING



THANK YOU

Aster Pharmacy Brand Guidelines

**Our Brand
Prescription: No
Over-The-Counter
Replications!**



CONTENTS

LOGO

Logo	5
Logo Greyscale	6
Logo Stacked & Extended	7
Logo Proportions	8
Logo Clear Space	9
Logo - Tagline Usage	10
Logo - Incorrect Usage	11

BRAND LANGUAGE

Colors	12
Typography	13
Regional Typography	14-18
Aarabic Typography	19
Web Typography	20

STATIONERY AND TEMPLATES

Business Card	21
A4 Letterhead	22
A4 Envelopes	23
A5 Envelopes	24
DL Envelope	25
A5 Notepad	26
ID Card	27
Powerpoint Template	28
E-mail Signature Template	29
Wall Clock	30
Backdrop	31

Bill Booklet - Manual	32
Dot Matrix	33
Envelope Front	34
Envelope Back	35

SIGNAGES

External Signages	36
Glass Glazing	37
Internal Signages - FMCG Category	38
Internal Signages - Pharmacy Category	39
Internal Signages - General	40
External Pharmacy Cross Sign	41

MARKETING & ADVERTISING COLLATERALS

Flyer/Newspaper Insert	42
Banner	43
Poster	44
Easel	45
Standee	46
Newspaper Ads	47
Hoardings - Horizontal	48
Hoardings - Vertical	49
Hoardings - Square	50
Road Median	51

UNIFORMS

Tshirt	52
Apron	53
Name Tag	54
Badge	55
Shoes	56

LOGO

Logo	5
Logo - Greyscale	6
Logo - Stacked & Extended	7
Logo - Clear Space	8
Logo - Tagline Usage	9
Logo - Minimum Size	10
Logo - Incorrect Usage	11

LOGO



Group Logo

LOGO GREYSCALE

Aster
PHARMACY
We'll Treat You Well

Aster
PHARMACY
We'll Treat You Well

■ CMYK
C 0 / M 0 / Y 0 / K 80

■ RGB
R 88 / G 89 / B 91

■ CMYK
C 0 / M 0 / Y 0 / K 60

■ RGB
R 128 / G 130 / B 133

■ CMYK
C 0 / M 0 / Y 0 / K 50

■ RGB
R 147 / G 149 / B 152

LOGO

STACKED & EXTENDED

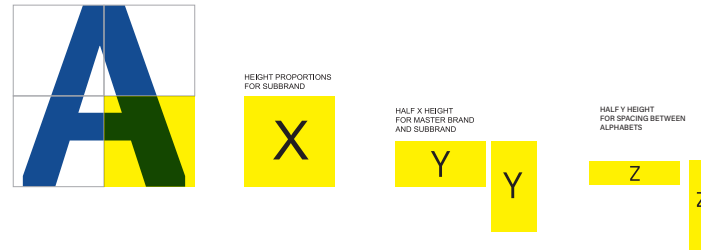

Primary Logo – Stacked



Primary Logo – Extended

STACKED AND EXTENDED LOGO

CLEAR SPACE



HEIGHT PROPORTIONS FOR SUBBRAND



HALF X HEIGHT FOR MASTER BRAND AND SUBBRAND



HALF Y HEIGHT FOR SPACING BETWEEN ALPHABETS

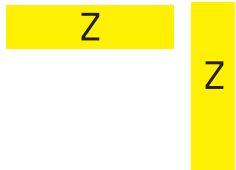

Stacked Logo



Extended Logo

LOGO

TAGLINE USAGE

The tagline will only be used in Stacked logo



Stacked Logo - Full Colour



Extended Logo - Full Colour

STACKED AND EXTENDED LOGO

MINIMUM SIZE

Aster
PHARMACY



12MM

Aster **PHARMACY**



6MM

LOGO

INCORRECT USAGE







- Do not change the proportions of the elements within the logo.
- Do not change the colour order.
- Do not put a stroke around any element of the logo.
- Do not change the orientation of the logo.
- Do not alter the logotype or use an alternate typeface.
- Do not crop the mark.
- Do not blend any other corporate name, text or logo.

BRAND LANGUAGE

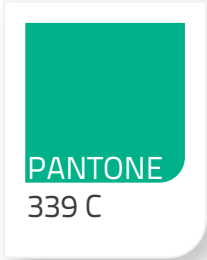
Colors	12
Typography	13
Regional Typography	14-18
Aarabic Typography	19
Web Typography	20

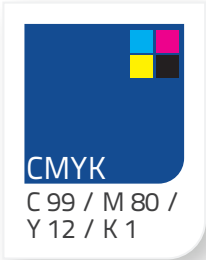
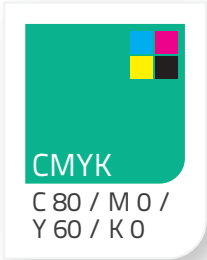
BRAND COLORS

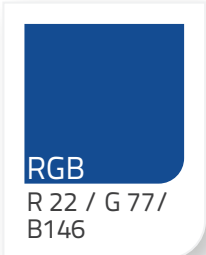
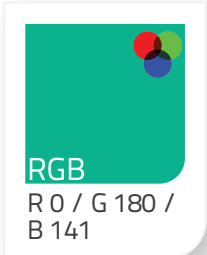
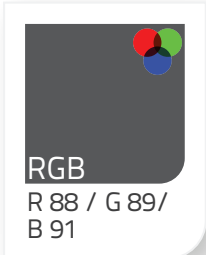
	COLOR	SECONDARY COLOR	SECONDARY COLOR
PANTONE	 <p>PANTONE 7687 C</p>	 <p>PANTONE 339 C</p>	 <p>PANTONE 425 C</p>
C M Y K	 <p>CMYK C 99 / M 80 / Y 12 / K 1</p>	 <p>CMYK C 80 / M 0 / Y 60 / K 0</p>	 <p>CMYK C 0 / M 0 / Y 0 / K 80</p>
WEB/DIGITAL	 <p>RGB R 22 / G 77 / B 146</p>	 <p>RGB R 0 / G 180 / B 141</p>	 <p>RGB R 88 / G 89 / B 91</p>

TYPOGRAPHY

ENGLISH

TitillumText22L Thin

ABCDEFGHIJKLMNOPQRSTUVWXYZ
abcdefghijklmnopqrstuvwxyz

TitillumText22L Regular

ABCDEFGHIJKLMNOPQRSTUVWXYZ
abcdefghijklmnopqrstuvwxyz

TitillumText22L Bold

ABCDEFGHIJKLMNOPQRSTUVWXYZ
abcdefghijklmnopqrstuvwxyz

TitillumText22L XBold

ABCDEFGHIJKLMNOPQRSTUVWXYZ
abcdefghijklmnopqrstuvwxyz

TYPOGRAPHY

MARATHI

Baloo 2 Regular

अआइईउऊऋऌँऐएऐऑओऔकखगघडच
छजझञटठडढणतथदधननपफबभमयररलळ

Baloo 2 SemiBold

अआइईउऊऋऌँऐएऐऑओऔकखगघडच
छजझञटठडढणतथदधननपफबभमयररलळ

Baloo 2 ExtraBold

अआइईउऊऋऌँऐएऐऑओऔकखगघडच
छजझञटठडढणतथदधननपफबभमयररलळ

Baloo 2 Medium

अआइईउऊऋऌँऐएऐऑओऔकखगघडच
छजझञटठडढणतथदधननपफबभमयररलळ

Baloo 2 Bold

अआइईउऊऋऌँऐएऐऑओऔकखगघडच
छजझञटठडढणतथदधननपफबभमयररलळ

TYPOGRAPHY

KANNADA

Baloo Tamma 2 Regular

ಅಆಇಈಉಊಋಌ಍ಎಏಐಋಠಢಡಢಣತಥ
ಕಖಗಘಙಚಛಱಜಝಞಟಠಡಢಣತಥ

Baloo Tamma 2 SemiBold

ಅಆಇಈಉಊಋಌ಍ಎಏಐಋಠಢಡಢಣತಥ
ಕಖಗಘಙಚಛಱಜಝಞಟಠಡಢಣತಥ

Baloo Tamma 2 ExtraBold

ಅಆಇಈಉಊಋಌ಍ಎಏಐಋಠಢಡಢಣತಥ
ಕಖಗಘಙಚಛಱಜಝಞಟಠಡಢಣತಥ

Baloo Tamma 2 Medium

ಅಆಇಈಉಊಋಌ಍ಎಏಐಋಠಢಡಢಣತಥ
ಕಖಗಘಙಚಛಱಜಝಞಟಠಡಢಣತಥ

Baloo Tamma 2 Bold

ಅಆಇಈಉಊಋಌ಍ಎಏಐಋಠಢಡಢಣತಥ
ಕಖಗಘಙಚಛಱಜಝಞಟಠಡಢಣತಥ

TYPOGRAPHY

TELUGU

Baloo Tammudu 2 Regular

అఆఇఈఉఊఋౠఎవ్విఒఓఔకఖ
గఘజచఛజఝఞటఠడఢణతథదధ

Baloo Tammudu 2 SemiBold

అఆఇఈఉఊఋౠఎవ్విఒఓఔకఖ
గఘజచఛజఝఞటఠడఢణతథదధ

Baloo Tammudu 2 ExtraBold

అఆఇఈఉఊఋౠఎవ్విఒఓఔకఖ
గఘజచఛజఝఞటఠడఢణతథదధ

Baloo Tammudu 2 Medium

అఆఇఈఉఊఋౠఎవ్విఒఓఔకఖ
గఘజచఛజఝఞటఠడఢణతథదధ

Baloo Tammudu 2 Bold

అఆఇఈఉఊఋౠఎవ్విఒఓఔకఖ
గఘజచఛజఝఞటఠడఢణతథదధ

TYPOGRAPHY

HINDI

Baloo 2 Regular

अआइईउऊऋऌएँऐऑओऔकखगघङचछज
झञटठडढणतथदधनपफबभमयररलळवशष

Baloo 2 SemiBold

अआइईउऊऋऌएँऐऑओऔकखगघङचछज
झञटठडढणतथदधनपफबभमयररलळवशष

Baloo 2 ExtraBold

अआइईउऊऋऌएँऐऑओऔकखगघङचछज
झञटठडढणतथदधनपफबभमयररलळवशष

Baloo 2 Medium

अआइईउऊऋऌएँऐऑओऔकखगघङचछज
झञटठडढणतथदधनपफबभमयररलळवशष

Baloo 2 Bold

अआइईउऊऋऌएँऐऑओऔकखगघङचछज
झञटठडढणतथदधनपफबभमयररलळवशष

TYPOGRAPHY

ARABIC

GE Dinar One - Light

ا ب ت ث ج ح خ د ذ ر ز س ش ص ض ط ظ ع غ ف ق ك ل م ن ه و ي

GE Dinar One - Light Italic

ا ب ت ث ج ح خ د ذ ر ز س ش ص ض ط ظ ع غ ف ق ك ل م ن ه و ي

GE Dinar One - Regular

ا ب ت ث ج ح خ د ذ ر ز س ش ص ض ط ظ ع غ ف ق ك ل م ن ه و ي

GE Dinar One - Medium

ا ب ت ث ج ح خ د ذ ر ز س ش ص ض ط ظ ع غ ف ق ك ل م ن ه و ي

GE Dinar One - Medium Italic

ا ب ت ث ج ح خ د ذ ر ز س ش ص ض ط ظ ع غ ف ق ك ل م ن ه و ي

GE Dinar One - Bold

ا ب ت ث ج ح خ د ذ ر ز س ش ص ض ط ظ ع غ ف ق ك ل م ن ه و ي

GE Dinar One - Black

ا ب ت ث ج ح خ د ذ ر ز س ش ص ض ط ظ ع غ ف ق ك ل م ن ه و ي

TYPOGRAPHY

ENGLISH - WEB

TitillumText22L Thin
ABCDEFGHIJKLMNOPQRSTUVWXYZ
abcdefghijklmnopqrstuvwxyz

TitillumText22L Regular
ABCDEFGHIJKLMNOPQRSTUVWXYZ
abcdefghijklmnopqrstuvwxyz

TitillumText22L Bold
ABCDEFGHIJKLMNOPQRSTUVWXYZ
abcdefghijklmnopqrstuvwxyz

Stag Sans Light
ABCDEFGHIJKLMNOPQRSTUVWXYZ
abcdefghijklmnopqrstuvwxyz

Stag Sans Book
ABCDEFGHIJKLMNOPQRSTUVWXYZ
abcdefghijklmnopqrstuvwxyz

Stag Sans Medium
ABCDEFGHIJKLMNOPQRSTUVWXYZ
abcdefghijklmnopqrstuvwxyz

STATIONERY AND TEMPLATES

Business Card	21
A4 Letterhead	22
A4 & A5 Envelopes	23
DL Envelope	24
A5 Notepad	25
ID Card	26
Powerpoint Template	27
Email Signature Template	28
Wall Clock	29
Backdrop	30
Bill Booklet - Manual	32
Dot Matrix	33
Medicine Cover Front	34
Medicine Cover Back	35

STATIONERY BUSINESS CARD



Specifications: 300 GSM Linen Half-White Texture Board

Logo size and position rule

The size and position of the Master Brand Logo on our brand business card is shown here. It is important to observe the clear-space rule from the top and right-hand edges to ensure clear readability.



Material Specification:

300 GSM Linen Half white
Texture board

STATIONERY

A4 LETTERHEAD

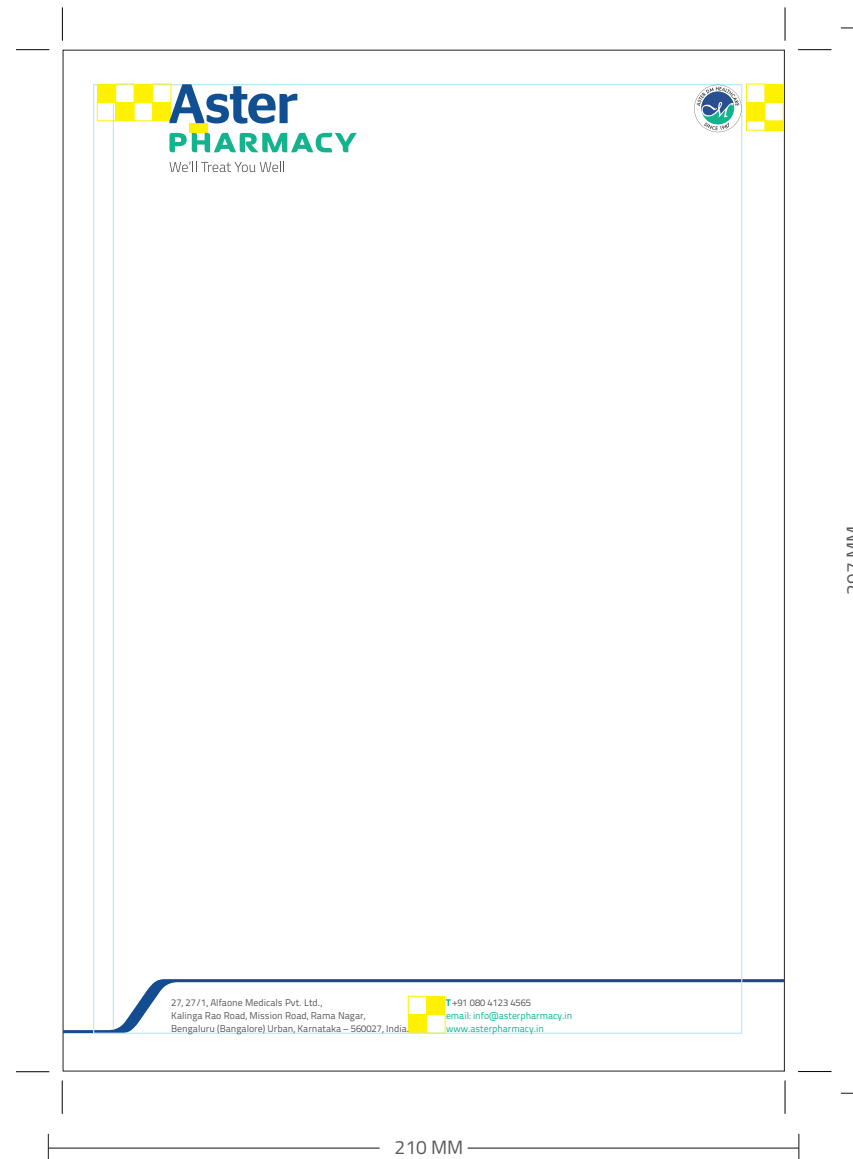

Specifications: 120 GSM Maplitho

Logo size and position rule

The size and position of the Master Brand Logo on our brand Letter head is shown here. It is important to observe the clear-space rule from the top and right-hand edges to ensure clear readability.



Material Specification:
120 GSM Maplitho

STATIONERY A4 ENVELOPES

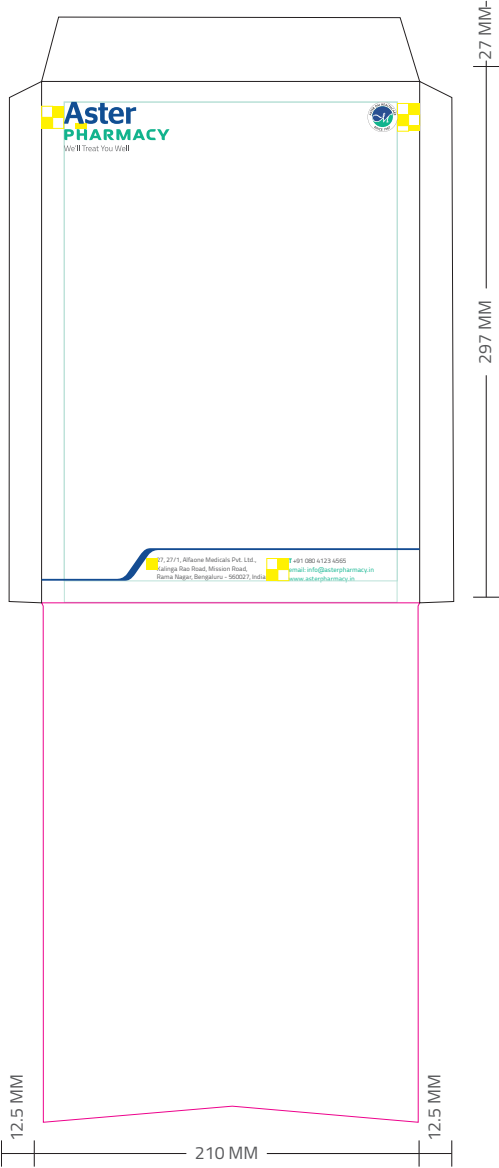

Envelope A4 **Specifications:** 120 GSM Maplitho

Logo size and position rule

The size and position of the Master Brand Logo on our brand A4 Envelope shown here. It is important to observe the clear-space rule from the top and right-hand edges to ensure clear readability.



Material Specification:
120 GSM Maplitho

STATIONERY A5 ENVELOPES



Envelope A5

Specifications: 120 GSM Maplitho

Logo size and position rule

The size and position of the Master Brand Logo on our brand A5 Envelope shown here. It is important to observe the clear-space rule from the top and right-hand edges to ensure clear readability.



Material Specification:

120 GSM Maplitho

STATIONERY DL ENVELOPE

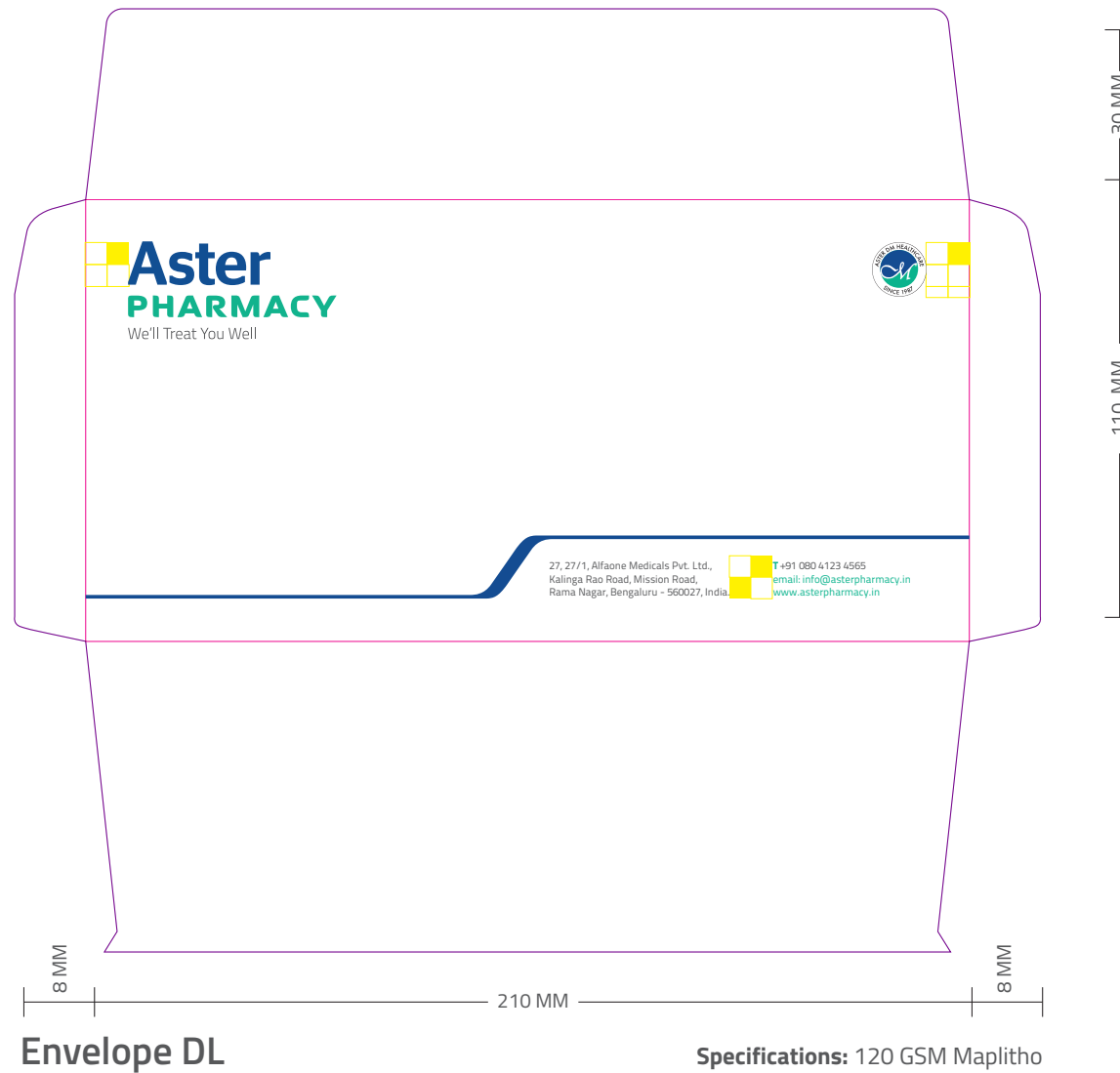

Logo size and position rule

The size and position of the Master Brand Logo on our brand A4 Envelope shown here. It is important to observe the clear-space rule from the top and right-hand edges to ensure clear readability.



Material Specification:
120 GSM Maplitho

STATIONERY

A5 NOTEPAD

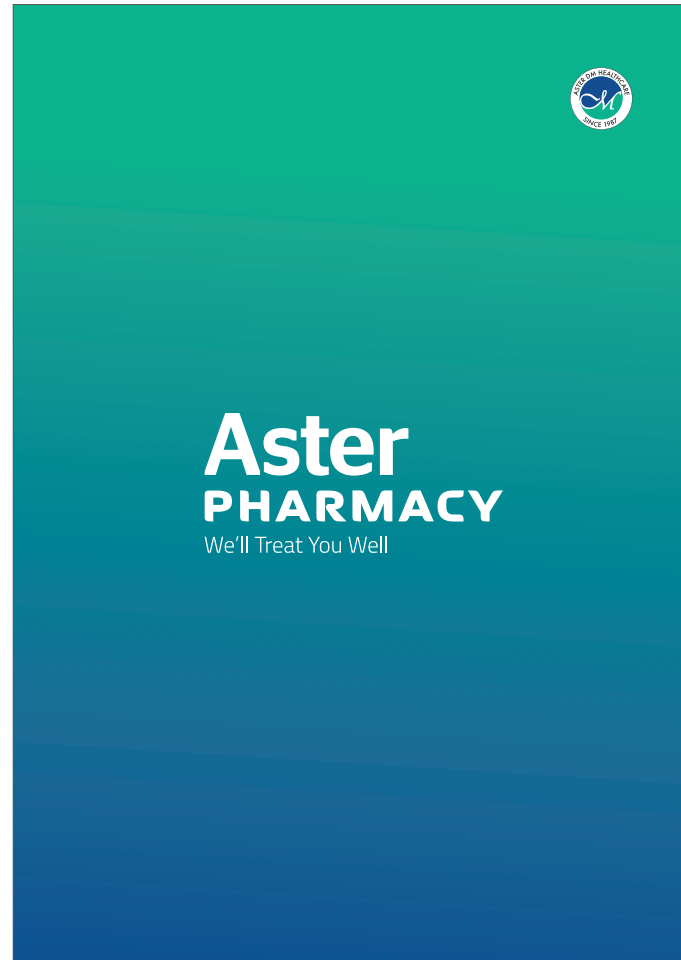

Cover

Specifications:

Cover Page – 130 GSM Glossy; Inner Pages – 90 GSM Sunshine Maplittho



Inside
148.5 MM

Logo size and position rule

The size and position of the Master Brand Logo on our brand Note pad shown here. It is important to observe the clear-space rule from the top and right-hand edges to ensure clear readability.

STATIONERY ID CARD

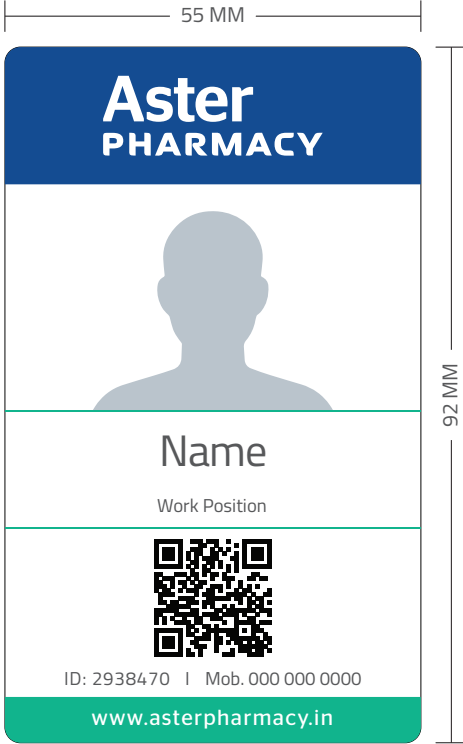

Front

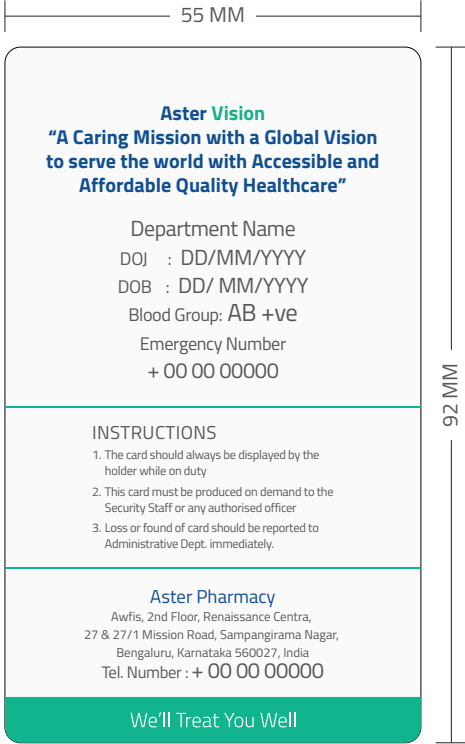

Back

Logo size and position rule

The size and position of the Master Brand Logo on our brand ID Card is shown here. It is important to observe the clear-space rule from the top and right-hand edges to ensure clear readability.

Material Specification:
PVC Card

STATIONERY POWERPOINT TEMPLATE

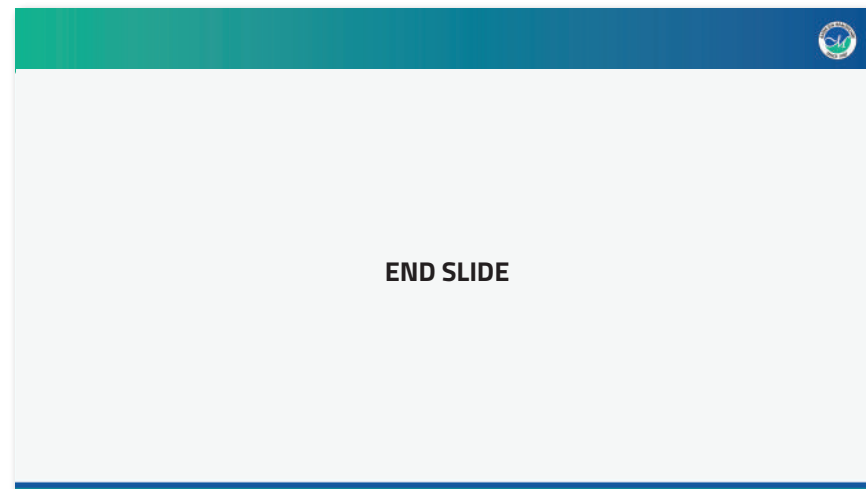
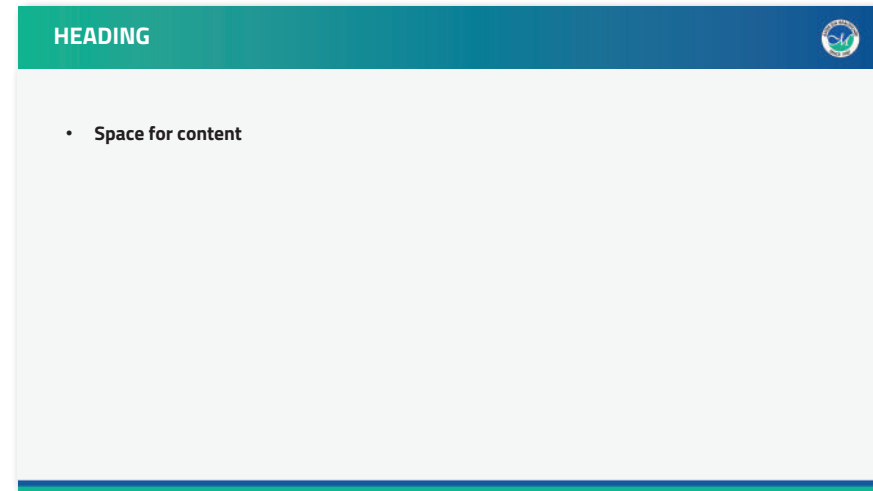

STATIONERY

EMAIL SIGNATURE TEMPLATE

First Name Last Name

Designation - Department



Aster Pharmacy

Awfis, 2nd Floor, Renaissance Centra,
27 & 27/1 Mission Road, Sampangirama Nagar,
Bengaluru, Karnataka 560027, India

T: 080-00000000 **M:** + 91 0000000000

E: name@asterpharmacy.in

www.asterpharmacy.in

Aster
PHARMACY

We'll Treat You Well



STATIONERY WALL CLOCK



EVENT/ PRESS CONFERENCE BACKDROP



BILL BOOKLET MANUAL



TAX INVOICE

#1, 1st Cross, Sumangali Sevashram Road, Cholanagar,
Bengaluru North, RT Nagar, Bengaluru - 560032,
For free home delivery, call: 89519 36732

Date: _____
Invoice No: _____

DL No.: Form 20 KA-B52-205937, Form 20B KA-B52-205939 GSTIN: 29AAUCA6096R1ZB
Form 21 KA-B52-205938, Form 21B KA-B52-205940

Name: _____ Doctor: _____
Address: _____

Qty.	Particulars	Mfrs.	Batch No.	Expiry	Amount
Total					

E. & OE _____ For Aster Pharmacy, Pharmacist

Note:
 1. Reverse Tax Mechanism on items are not applicable.
 2. Exchange within 7 days from date of purchase.
 3. Original bill mandatory for exchange of products.
 4. Items requiring cold storage will not be returned or exchanged.
 5. Aster Pharmacy reserves the right to refuse returns for certain products/medicines.

Alfaone Retail Pharmacies Private Limited



Aster
PHARMACY
We'll Treat You Well

8.5 INCHES

Specifications: 90 GSM

DOT MATRIX

TAX INVOICE											
Bill No.:		Date:	Time:	Name:			Age:	Gender:	Ref. No.:		Doctor:
Branch:		Address:			Contact No.:		DL. No.:		GSTIN: 32AAUCA6096R1Z0		Terminal No.:
Qty.	Particulars	HSN Code	Mfrs.	Batch No.	Expiry	SCH	MRP	CGST %	SGST %	Tax	Amount
E&OE										Total	
CIN:		Registered Office:								Discount	
CGST:					SGST:					Net Total	
Note: 1. Reverse Tax Mechanism on items are not applicable. 2. Exchange within 7 days from date of purchase. 3. Original bill mandatory for exchange of products. 4. Insulin, vaccines, and other items requiring cold storage cannot be returned or exchanged. 5. Aster Pharmacy reserves the right to refuse returns for certain products/medicines.								For Aster Pharmacy, Pharmacist			
Alfaone Retail Pharmacies Private Limited								 We'll Treat You Well			

4 INCHES

10 INCHES

Specifications: 65 GSM

STATIONERY

MEDICINE COVER FRONT



Specifications: 70 GSM Maplitho Brown



STATIONERY

MEDICINE COVER BACK



Name.....

Please take tablet/capsule/syrup
 before Food after food
 morning afternoon evening night

Remarks.....

FREE 
HOME DELIVERY
Call: 00000 00000

Aster
PHARMACY
 We'll Treat You Well

10 INCHES

12 INCHES



Name.....

Please take tablet/capsule/syrup
 before Food after food
 morning afternoon evening night

Remarks.....

FREE 
HOME DELIVERY
Call: 00000 00000

Aster
PHARMACY
 We'll Treat You Well

6 INCHES

8 INCHES



Name.....

Please take tablet/capsule/syrup
 before Food after food
 morning afternoon evening night

Remarks.....

FREE 
HOME DELIVERY
Call: 00000 00000

Aster
PHARMACY
 We'll Treat You Well

4 INCHES

6 INCHES

Specifications: 70 GSM Maplitho Brown

SIGNAGES

External Signages	36
Glass Glazing	37
Internal Signages - FMCG Category	38
Internal Signages - Pharmacy Category	39
Internal Signages - General	40
External Pharmacy Cross Sign	41

EXTERNAL SIGNAGES

- The isolation area on either sides of the primary and Group logos is indicated by 'A', which is the size of the letter 'A' in the primary logo.
- The amount of isolation area above and below the primary logo is indicated by 'B', which is an equal amount of space from the margins above and below it.
- The base of the regional language is aligned to the base of the primary logo.
- The amount of isolation area between the primary logo and the regional text is indicated by 'C', which is an equal amount of space from the centre of the blue diagonal design element to the primary logo and regional text respectively.

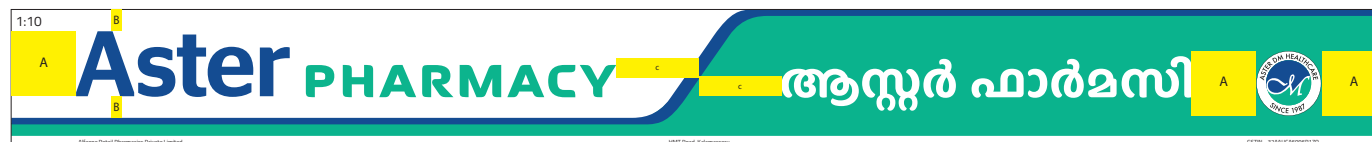
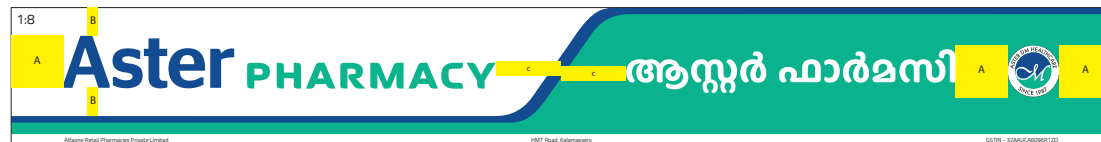

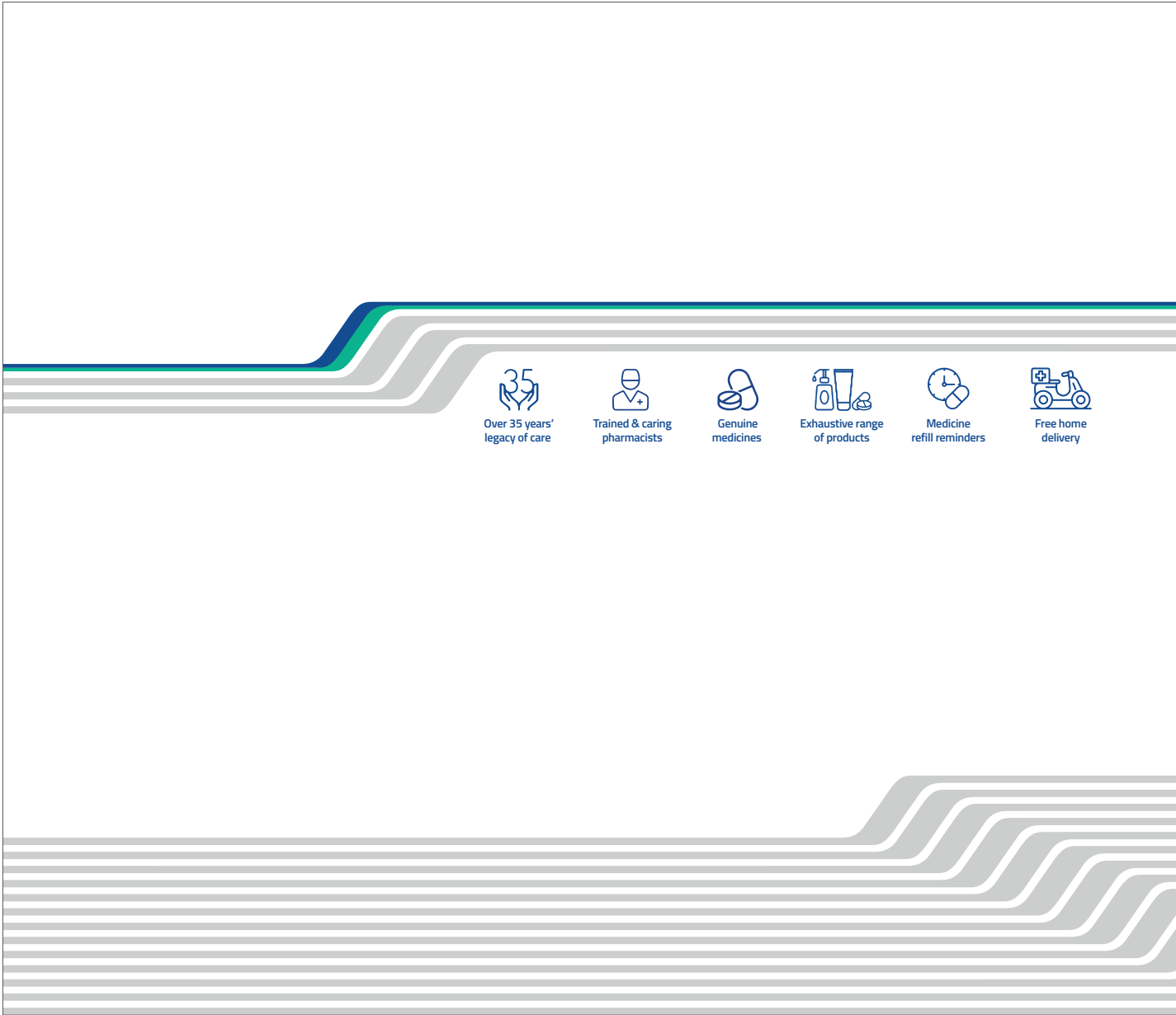

GLASS GLAZING





A decorative graphic consisting of a series of horizontal lines. The top line is a solid teal color, followed by several grey lines of varying thicknesses. The lines are arranged in a way that they appear to flow from left to right, with some lines curving upwards and then downwards. In the center of this graphic, there is a row of six icons, each with a corresponding text label below it.

- 

Over 35 years' legacy of care
- 

Trained & caring pharmacists
- 

Genuine medicines
- 

Exhaustive range of products
- 

Medicine refill reminders
- 

Free home delivery

INTERNAL SIGNAGES

FMCG CATEGORY

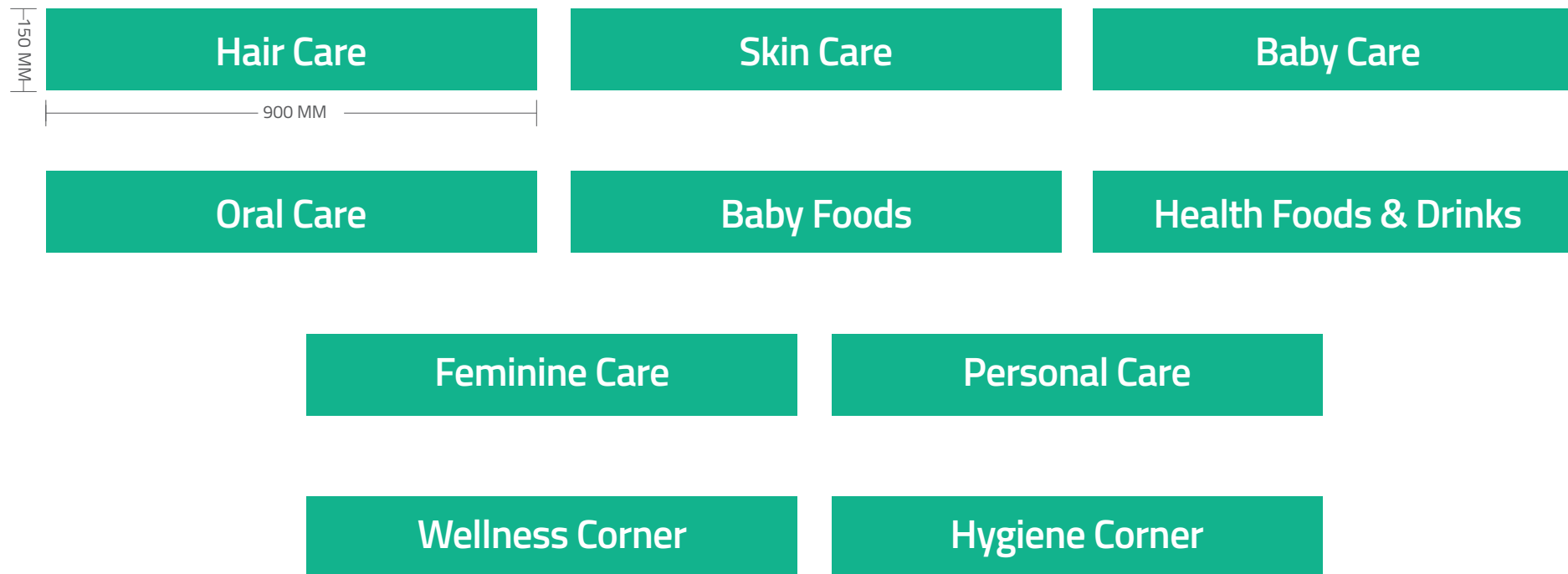

Specifications: 3M IJ40 C vinyl with 8520 lamination print and cut vinyl

INTERNAL SIGNAGES

PHARMACY CATEGORY

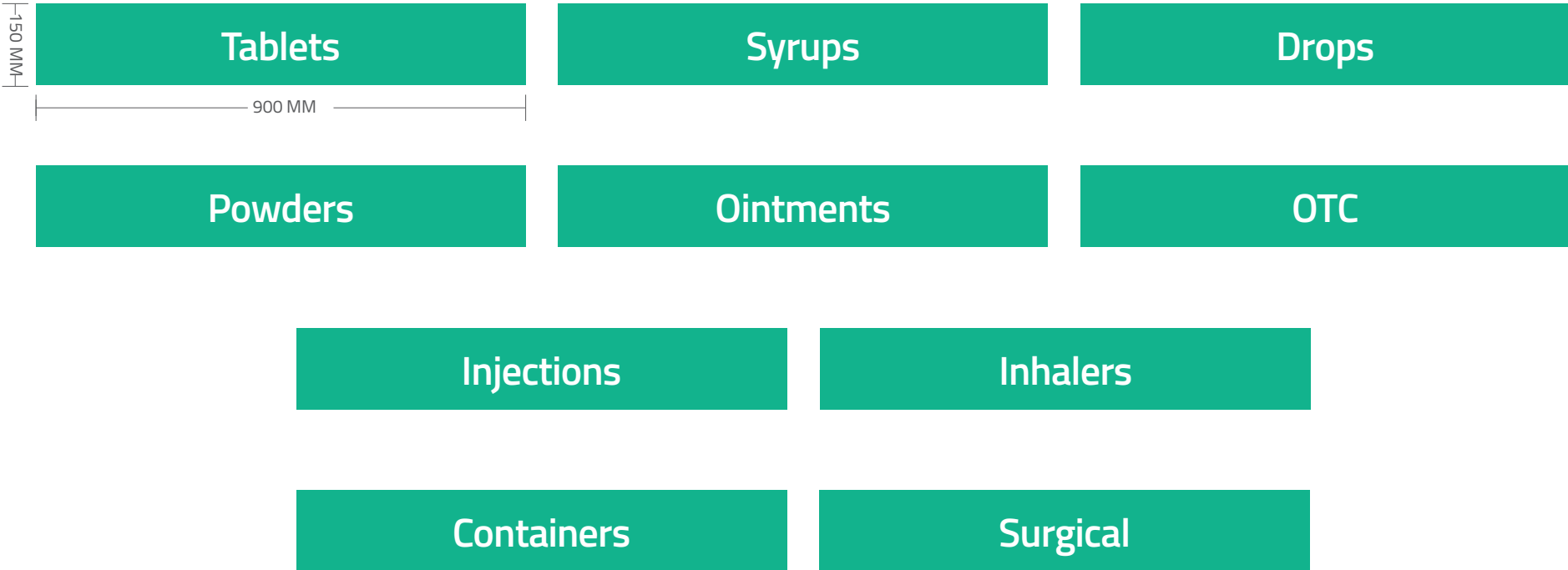

Specifications: 3M IJ40 C vinyl with 8520 lamination print and cut vinyl

INTERNAL SIGNAGES

GENERAL



Specifications: 3M IJ40 C vinyl with 8520 lamination print and cut vinyl

EXTERNAL PHARMACY CROSS SIGN



Bottle Green
PMS 006646
CMYK 90-34-90-26
RGB 1-104-63
HEX #006646
PANTONE 7728 C

MARKETING & ADVERTISING COLLATERALS

Flyer/Newspaper Insert	42
Banner	43
Poster	44
Easel	45
Standee	46
Newspaper Ads	47
Hoardings - Horizontal	48
Hoardings - Vertical	49
Hoardings - Square	50
Road Median	51

The layouts are only for logo placement and spacing reference

FLYER/NEWSPAPER INSERT



ASTER PHARMACY
SINCE 1981

**Your friendly neighbourhood
pharmacy, now open at
Jawahar Nagar, Kadavanthra.**

We promise you:

- 
Over 35 years' legacy of care
- 
Trained & caring pharmacists
- 
Genuine medicines
- 
Exhaustive range of products
- 
Medicine refill reminders
- 
Free home delivery

Our product range:

- Prescription & OTC drugs • Personal & hygiene care • Feminine care • Baby care
- Wellness • Sports nutrition • Surgicals & disposables • Medical devices

**For free home delivery,
call: 00000 00000**

Find us at: Door No.68/1313 of
Re.Sy No.1-20-822 of Kacheri Village,
Kozhikode Taluk, Kozhikode

**Aster
PHARMACY**
We'll Treat You Well

210 MM

148.5 MM

BANNER



Your friendly neighbourhood
pharmacy, now open at
Jawahar Nagar, Kadavanthra.

Visit us at
25/ 732 Moopans , Padamughal-Palachuvadu Road, Satellite Township,
Padamughal, Kakkanad, Ernakulam
For free home delivery, call: 00000 00000

Aster
PHARMACY
We'll Treat You Well



3 FEET

5 FEET

POSTER



Your friendly neighbourhood pharmacy, now open at
Jawahar Nagar, Kadavanthra.

We promise you:

-  Over 35 years' legacy of care
-  Trained & caring pharmacists
-  Genuine medicines
-  Exhaustive range of products
-  Medicine refill reminders
-  Free home delivery

Our product range:

- Prescription & OTC drugs • Personal & hygiene care • Feminine care • Baby care
- Wellness • Sports nutrition • Surgicals & disposables • Medical devices

For free home delivery, call: 00000 00000
Find us at: Door No.68/1313 of Re.Sy No.1-20-B22 of Kacheri Village, Kozhikode Taluk, Kozhikode

Aster
PHARMACY
We'll Treat You Well

420 MM

297 MM

EASEL

3ft



Your friendly neighbourhood pharmacy, now open at Jawahar Nagar, Kadavanthra.

WE PROMISE YOU:

-  Over 35 years' legacy of care
-  Trained & caring pharmacists
-  Genuine medicines
-  Exhaustive range of products
-  Medicine refill reminders
-  Free home delivery

OUR PRODUCT RANGE:

- Prescription & OTC drugs • Personal care & hygiene • Feminine care
- Baby care • Wellness • Sports nutrition • Surgical & disposables • Medical devices
- And much, much more

For free home delivery, call: 00000 00000

Aster
PHARMACY
We'll Treat You Well

4ft

STANDEE



Your friendly neighbourhood pharmacy, now open at **Jawahar Nagar, Kadavanthra.**

WE PROMISE YOU:

- 
 Over 35 years' legacy of care
- 
 Trained & caring pharmacists
- 
 Genuine medicines
- 
 Exhaustive range of products
- 
 Medicine refill reminders
- 
 Free home delivery

OUR PRODUCT RANGE:

- Prescription & OTC drugs • Personal care & hygiene • Feminine care
- Baby care • Wellness • Sports nutrition • Surgical & disposables
- Medical devices • And much, much more

For free home delivery, call: 00000 00000

Aster
PHARMACY
We'll Treat You Well

6 Feet

3 Feet

NEWSPAPER ADS



Your friendly neighbourhood pharmacy, now open at Jawahar Nagar, Kadavanthra.

Lorem ipsum dolor sit amet, consectetur adipiscing elit, sed do eiusmod tempor incididunt ut labore et dolore magna aliqua. Ut enim ad minim veniam, quis nostrud exercitation ullamco laboris nisi ut aliquip ex ea commodo consequat. Duis aute irure dolor in reprehenderit in voluptate velit esse cillum dolore eu fugiat nulla pariatur. Excepteur sint occaecat cupidatat non proident, sunt in culpa qui officia deserunt mollit anim id est laborum.

WE PROMISE YOU:

- Over 35 years' legacy of care
- Trained & caring pharmacists
- Genuine medicines
- Exhaustive range of products
- Medicine refill reminders
- Free home delivery

OUR PRODUCT RANGE:

- Prescription & OTC drugs • Personal care & hygiene • Feminine care • Baby care • Wellness
- Sports nutrition • Surgical & disposables • Medical devices • And much, much more

For free home delivery, call: 00000 00000

Aster PHARMACY
We'll Treat You Well

Full Page



Your friendly neighbourhood pharmacy, now open at Jawahar Nagar, Kadavanthra.

Lorem ipsum dolor sit amet, consectetur adipiscing elit, sed do eiusmod tempor incididunt ut labore et dolore magna aliqua. Ut enim ad minim veniam, quis nostrud exercitation ullamco laboris nisi ut aliquip ex ea commodo consequat. Duis aute irure dolor in reprehenderit in voluptate velit esse cillum dolore eu fugiat nulla pariatur. Excepteur sint occaecat cupidatat non proident, sunt in culpa qui officia deserunt mollit anim id est laborum.

WE PROMISE YOU:

- Over 35 years' legacy of care
- Trained & caring pharmacists
- Genuine medicines
- Exhaustive range of products
- Medicine refill reminders
- Free home delivery

OUR PRODUCT RANGE:

- Prescription & OTC drugs • Personal care & hygiene • Feminine care
- Baby care • Wellness • Sports nutrition • Surgical & disposables
- Medical devices • And much, much more

For free home delivery, call: 00000 00000

Aster PHARMACY
We'll Treat You Well

Half Page



Your friendly neighbourhood pharmacy, now open at Jawahar Nagar, Kadavanthra.

Lorem ipsum dolor sit amet, consectetur adipiscing elit, sed do eiusmod tempor incididunt ut labore et dolore magna aliqua. Ut enim ad minim veniam, quis nostrud exercitation ullamco laboris nisi ut aliquip ex ea commodo consequat. Duis aute irure dolor in reprehenderit in voluptate velit esse cillum dolore eu fugiat nulla pariatur. Excepteur sint occaecat cupidatat non proident, sunt in culpa qui officia deserunt mollit anim id est laborum.

WE PROMISE YOU:

- Over 35 years' legacy of care
- Trained & caring pharmacists
- Genuine medicines
- Exhaustive range of products
- Medicine refill reminders
- Free home delivery

OUR PRODUCT RANGE:

- Prescription & OTC drugs • Personal care & hygiene • Feminine care • Baby care • Wellness
- Sports nutrition • Surgical & disposables • Medical devices • And much, much more

For free home delivery, call: 00000 00000

Aster PHARMACY
We'll Treat You Well

Quarter Page

HOARDINGS HORIZONTAL



**Your friendly neighbourhood pharmacy,
now open at **Jawahar Nagar, Kadavanthra.****

WE PROMISE YOU:

-  Over 35 years' legacy of care
-  Trained & caring pharmacists
-  Genuine medicines
-  Exhaustive range of products
-  Medicine refill reminders
-  Free home delivery

OUR PRODUCT RANGE:

- Prescription & OTC drugs
- Personal care & hygiene
- Feminine care
- Baby care
- Wellness
- Sports nutrition
- Surgicals & disposables
- Medical devices
- And much, much more

Aster
PHARMACY
We'll Treat You Well

For free home delivery, call: 00000 00000

HOARDINGS

VERTICAL



**Your friendly neighbourhood
pharmacy, now open at
Jawahar Nagar, Kadavanthra.**

WE PROMISE YOU:

-  Over 35 years' legacy of care
-  Trained & caring pharmacists
-  Genuine medicines
-  Exhaustive range of products
-  Medicine refill reminders
-  Free home delivery

OUR PRODUCT RANGE:

- Prescription & OTC drugs • Personal care & hygiene • Feminine care • Baby care • Wellness
- Sports nutrition • Surgicals & disposables • Medical devices • And much, much more

Aster
PHARMACY
We'll Treat You Well

For free home delivery,
call: 00000 00000

HOARDINGS SQUARE



**Your friendly neighbourhood pharmacy,
now open at **Jawahar Nagar, Kadavanthra.****

WE PROMISE YOU:

-  Over 35 years' legacy of care
-  Trained & caring pharmacists
-  Genuine medicines
-  Exhaustive range of products
-  Medicine refill reminders
-  Free home delivery

OUR PRODUCT RANGE:

- Prescription & OTC drugs • Personal care & hygiene • Feminine care • Baby care • Wellness
- Sports nutrition • Surgicals & disposables • Medical devices • And much, much more

**For free home delivery,
call: 00000 00000**

Aster
PHARMACY
We'll Treat You Well

ROAD MEDIAN



Your friendly neighbourhood
pharmacy, now open at
Jawahar Nagar, Kadavanthra.

For free home delivery,
call: **00000 00000**

Aster
PHARMACY
We'll Treat You Well

UNIFORMS

Apron	52
T-shirt	53
Name Tag	54
Badge	55
Shoes	56

UNIFORM

APRON - PHARMACIST



Gabardine Fabric White 65% polyester & 35% cotton

Logo



3 x 3 cm

Aster
PHARMACY



Vertical Logo
2 cm H

UNIFORM T-SHIRT



Polo T-shirt

Logo



3 x 3 cm

Aster
PHARMACY



Vertical Logo
2 cm H

Aster
PHARMACY
We'll Treat You Well



White Logo
2 cm H

UNIFORM NAME TAG



Size- 70 mm*25 mm, Metal Badge with UV printing

UNIFORM BADGE



**UNIFORM
SHOES**



Aster
PHARMACY
We'll Treat You Well

Aster Labs Brand Guidelines

Why did we finalize these lab brand guidelines?

They tested positive for inspiring trust!

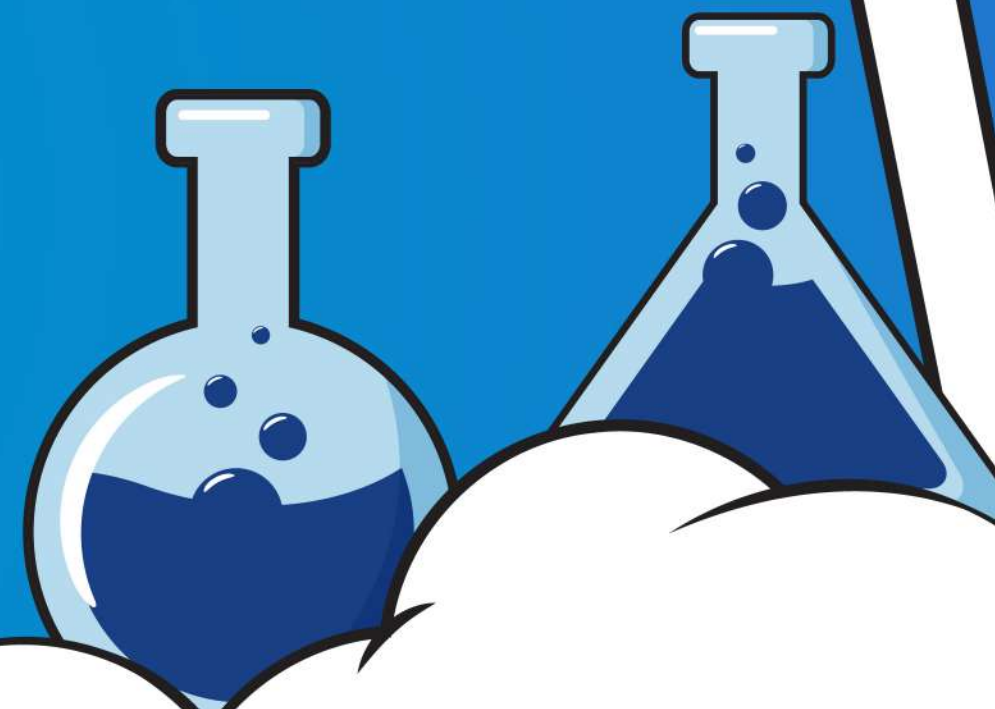

CONTENTS

BRAND

Vision	1
Values	2
Mission	3
Promise	4

LOGO

Logo	5
Logo Greyscale	6
Logo Proportions	7
Logo Clear Space	8
Logo - Tagline Usage	9
Logo - Incorrect Use	10

BRAND LANGUAGE

Colors	11
Typography	12
Regional Typography	13-17
Aarabic Typography	18
Web Typography	19

STATIONERY & TEMPLATES

Business Card	20
A4 LetterHead	21
A4 Envelope	22
A5 Envelope	23
DLF Envelope	24
A5 Notepad	25
ID card	26
Powerpoint Template	27
E-mail Signature Template	28
Wall Clock	29
Backdrop	30
CD Label	31
CD Cover	32
Forms	33
Report Sheet	34
Parking Sticker	35

SIGNAGES

External Signage	36
Internal Signage	37
Internal Wall Branding	38
Reception	39

MARKETING & ADVERTISING COLLATERALS

Flyer/Newspaper Insert	40
Banner	41
Poster	42
Easel	43
Standee	44
Newspaper Ads	45
Hoardings - Horizontal	46
Hoardings - Vertical	47
Hoardings - Square	48
Road Median	49

UNIFORM

Doctor's / Phlebotomist Apron	50
Customer Relations -Male	51
Customer Relations- Female	52
T-Shirt	53
Home Collection Bag	54
Name tag	55
Badge	56
Shoes	57

LOGO

Logo	5
Logo Greyscale	6
Logo Clear Space	7
Logo - Tagline Usage	8
Logo - Minimum Size	9
Logo - Incorrect Use	10

LOGO

Aster LABS
We'll Treat You Well



Group Logo

LOGO
GREYSCALE

Aster LABS
We'll Treat You Well



 CMYK
C 0 / M 0 / Y 0 / K 80

 CMYK
C 0 / M 0 / Y 0 / K 60

 CMYK
C 0 / M 0 / Y 0 / K 50

 RGB
R 88 / G 89 / B 91

 RGB
R 128 / G 130 / B 133

 RGB
R 147 / G 149 / B 152

LOGO CLEAR SPACE

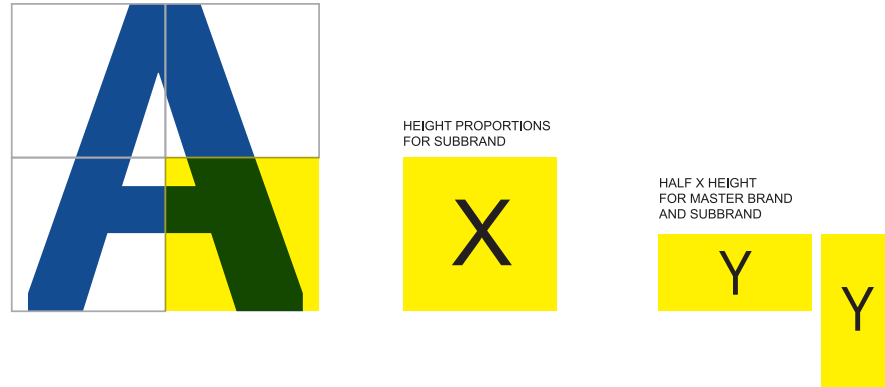

LOGO

TAGLINE USAGE

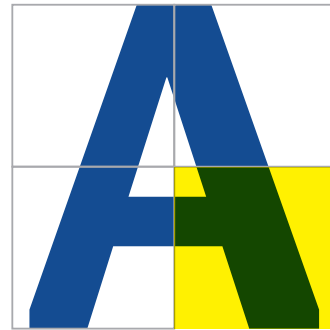

HEIGHT PROPORTIONS
FOR SUBBRAND



HALF Y HEIGHT
FOR MASTER BRAND
AND SUBBRAND



We'll Treat You Well

LOGO
MINIMUM SIZE



LOGO INCORRECT USAGE

 <p>NO PERSPECTIVE</p>	 <p>NO ROTATION</p>	 <p>NO OUTLINE</p>	 <p>NO CHANGING POSITIONS</p>	 <p>NO HORIZONTAL SCALING</p>
 <p>DO NOT CHANGE THE COLOUR ORDER.</p>	 <p>DO NOT CHANGE THE COLOUR ORDER.</p>	 <p>NO VERTICAL STACKING</p>	 <p>NO WARPING</p>	 <p>NO CHANGING PROPORTIONS</p>
 <p>DO NOT CROP THE MARK.</p>	 <p>NO ADDITIONAL 3D EFFECTS</p>	 <p>NO UNREADABLE BACKGROUNDS</p>	 <p>NO TRANSPARENCY</p>	 <p>NO DROP SHADOW</p>

- Do not change the proportions of the elements within the logo.
- Do not change the colour order.
- Do not put a stroke around any element of the logo.
- Do not change the orientation of the logo.
- Do not alter the logotype or use an alternate typeface.
- Do not crop the mark.
- Do not blend any other corporate name, text or logo.

BRAND LANGUAGE

Colors	11
Typography	12
Regional Typography	13-17
Aarabic Typography	18
Web Typography	19

BRAND COLORS

CORPORATE COLOR

SECONDARY COLOR

GREYSCALE

TAGLINE COLOR

PANTONE

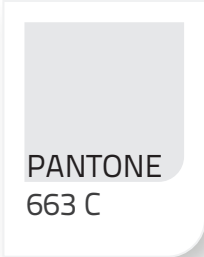
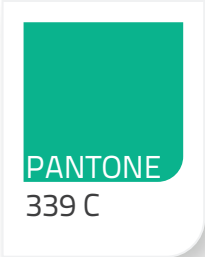

CMYK

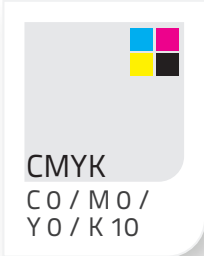
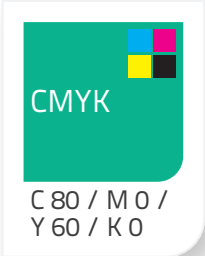
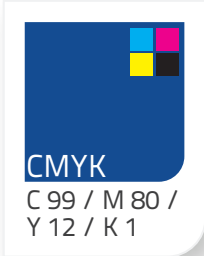

WEB/DIGITAL

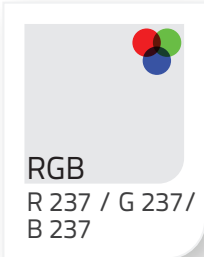
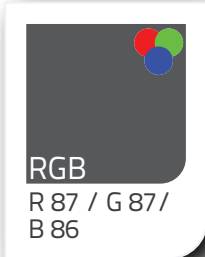
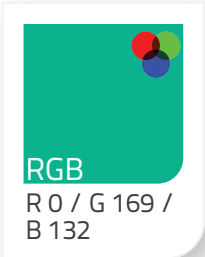
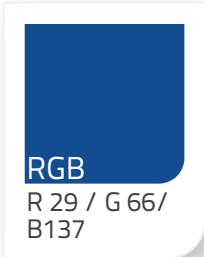

TYPOGRAPHY

ENGLISH

TitillumText22L Thin

ABCDEFGHIJKLMNOPQRSTUVWXYZ
abcdefghijklmnopqrstuvwxyz

TitillumText22L Regular

ABCDEFGHIJKLMNOPQRSTUVWXYZ
abcdefghijklmnopqrstuvwxyz

TitillumText22L Bold

ABCDEFGHIJKLMNOPQRSTUVWXYZ
abcdefghijklmnopqrstuvwxyz

TitillumText22L XBold

ABCDEFGHIJKLMNOPQRSTUVWXYZ
abcdefghijklmnopqrstuvwxyz

TYPOGRAPHY

MARATHI

Baloo 2 Regular

अआइईउऊऋऌॠॡऐएऐऑओऔकखगघडच
छजझञटठडढणतथदधननपफबभमयररलळ

Baloo 2 SemiBold

अआइईउऊऋऌॠॡऐएऐऑओऔकखगघडच
छजझञटठडढणतथदधननपफबभमयररलळ

Baloo 2 ExtraBold

अआइईउऊऋऌॠॡऐएऐऑओऔकखगघडच
छजझञटठडढणतथदधननपफबभमयररलळ

Baloo 2 Medium

अआइईउऊऋऌॠॡऐएऐऑओऔकखगघडच
छजझञटठडढणतथदधननपफबभमयररलळ

Baloo 2 Bold

अआइईउऊऋऌॠॡऐएऐऑओऔकखगघडच
छजझञटठडढणतथदधननपफबभमयररलळ

TYPOGRAPHY

TELUGU

Baloo Tammudu 2 Regular

అఆఇఈఉఊఋౠఎవ్ఐఒఓఔకఖ
గఘజచఛజఝఞటఠడఢణతథదధ

Baloo Tammudu 2 SemiBold

అఆఇఈఉఊఋౠఎవ్ఐఒఓఔకఖ
గఘజచఛజఝఞటఠడఢణతథదధ

Baloo Tammudu 2 ExtraBold

అఆఇఈఉఊఋౠఎవ్ఐఒఓఔకఖ
గఘజచఛజఝఞటఠడఢణతథదధ

Baloo Tammudu 2 Medium

అఆఇఈఉఊఋౠఎవ్ఐఒఓఔకఖ
గఘజచఛజఝఞటఠడఢణతథదధ

Baloo Tammudu 2 Bold

అఆఇఈఉఊఋౠఎవ్ఐఒఓఔకఖ
గఘజచఛజఝఞటఠడఢణతథదధ

TYPOGRAPHY

HINDI

Baloo 2 Regular

अआइईउऊऋऌएँऐऑओऔकखगघङचछज
झञटठडढणतथदधनपफबभमयररलळवशष

Baloo 2 SemiBold

अआइईउऊऋऌएँऐऑओऔकखगघङचछज
झञटठडढणतथदधनपफबभमयररलळवशष

Baloo 2 ExtraBold

अआइईउऊऋऌएँऐऑओऔकखगघङचछज
झञटठडढणतथदधनपफबभमयररलळवशष

Baloo 2 Medium

अआइईउऊऋऌएँऐऑओऔकखगघङचछज
झञटठडढणतथदधनपफबभमयररलळवशष

Baloo 2 Bold

अआइईउऊऋऌएँऐऑओऔकखगघङचछज
झञटठडढणतथदधनपफबभमयररलळवशष

TYPOGRAPHY

ARABIC

GE Dinar One - Light

ا ب ت ث ج ح خ د ذ ر ز س ش ص ض ط ظ ع غ ف ق ك ل م ن ه و ي

GE Dinar One - Light Italic

ا ب ت ث ج ح خ د ذ ر ز س ش ص ض ط ظ ع غ ف ق ك ل م ن ه و ي

GE Dinar One - Regular

ا ب ت ث ج ح خ د ذ ر ز س ش ص ض ط ظ ع غ ف ق ك ل م ن ه و ي

GE Dinar One - Medium

ا ب ت ث ج ح خ د ذ ر ز س ش ص ض ط ظ ع غ ف ق ك ل م ن ه و ي

GE Dinar One - Medium Italic

ا ب ت ث ج ح خ د ذ ر ز س ش ص ض ط ظ ع غ ف ق ك ل م ن ه و ي

GE Dinar One - Bold

ا ب ت ث ج ح خ د ذ ر ز س ش ص ض ط ظ ع غ ف ق ك ل م ن ه و ي

GE Dinar One - Black

ا ب ت ث ج ح خ د ذ ر ز س ش ص ض ط ظ ع غ ف ق ك ل م ن ه و ي

TYPOGRAPHY

ENGLISH - WEB

TitillumText22L Thin

ABCDEFGHIJKLMNOPQRSTUVWXYZ
abcdefghijklmnopqrstuvwxyz

TitillumText22L Regular

ABCDEFGHIJKLMNOPQRSTUVWXYZ
abcdefghijklmnopqrstuvwxyz

TitillumText22L Bold

ABCDEFGHIJKLMNOPQRSTUVWXYZ
abcdefghijklmnopqrstuvwxyz

Stag Sans Light

ABCDEFGHIJKLMNOPQRSTUVWXYZ
abcdefghijklmnopqrstuvwxyz

Stag Sans Book

ABCDEFGHIJKLMNOPQRSTUVWXYZ
abcdefghijklmnopqrstuvwxyz

Stag Sans Medium

ABCDEFGHIJKLMNOPQRSTUVWXYZ
abcdefghijklmnopqrstuvwxyz

STATIONERY & TEMPLATES

Business Card	20
A4 Letterhead	21
A4 Envelope	22
A5 Envelope	23
DLF Envelope	24
A5 Notepad	25
ID card	26
Powerpoint Template	27
E-mail Signature Template	28
Wall Clock	29
Backdrop	30
CD Label	31
CD Cover	32

Forms	33
Report Sheet	34
Parking Sticker	35

STATIONERY BUSINESS CARD



Specifications: 300 GSM Linen Half-White Texture Board

Logo size and position rule

The size and position of the Master Brand Logo on our brand business card is shown here. It is important to observe the clear-space rule from the top and right-hand edges to ensure clear readability.

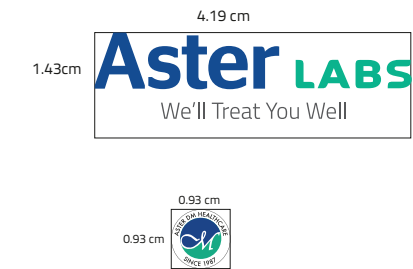

Material Specification:

300 GSM Linen Half white
Texture board

STATIONERY

A4 LETTERHEAD



Size: A4

Paper: 120 GSM maplitho

Logo size and position rule

The size and position of the Master Brand Logo on our brand Letter head is shown here. It is important to observe the clear-space rule from the top and right-hand edges to ensure clear readability.



Material Specification:

120 GSM Maplitho

STATIONERY A4 ENVELOPE

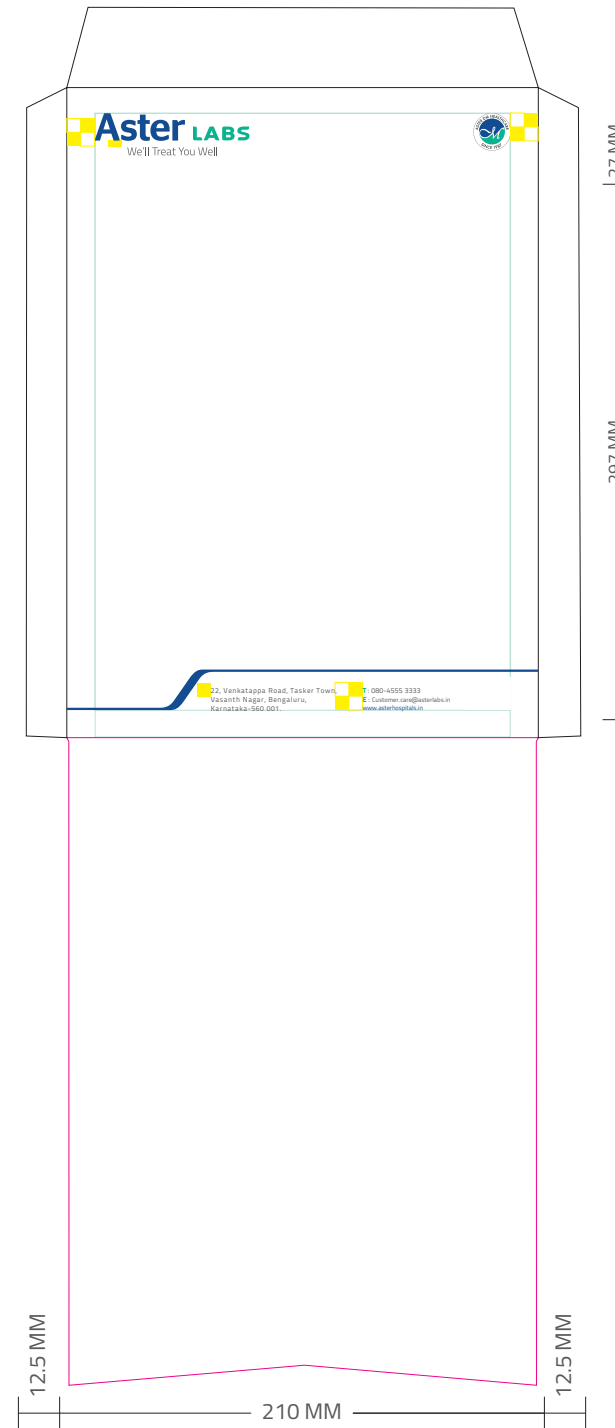

Envelope A4

Specifications: 120 GSM Maplitho

Logo size and position rule

The size and position of the Master Brand Logo on our brand A4 Envelope shown here. It is important to observe the clear-space rule from the top and right-hand edges to ensure clear readability.

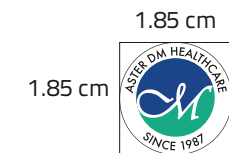

Material Specification:
120 GSM Maplitho

STATIONERY A5 ENVELOPE



Envelope A5

Specifications: 120 GSM Maplitho

Logo size and position rule

The size and position of the Master Brand Logo on our brand A5 Envelope shown here. It is important to observe the clear-space rule from the top and right-hand edges to ensure clear readability.



Material Specification:

120 GSM Maplitho

STATIONERY DLF ENVELOPE

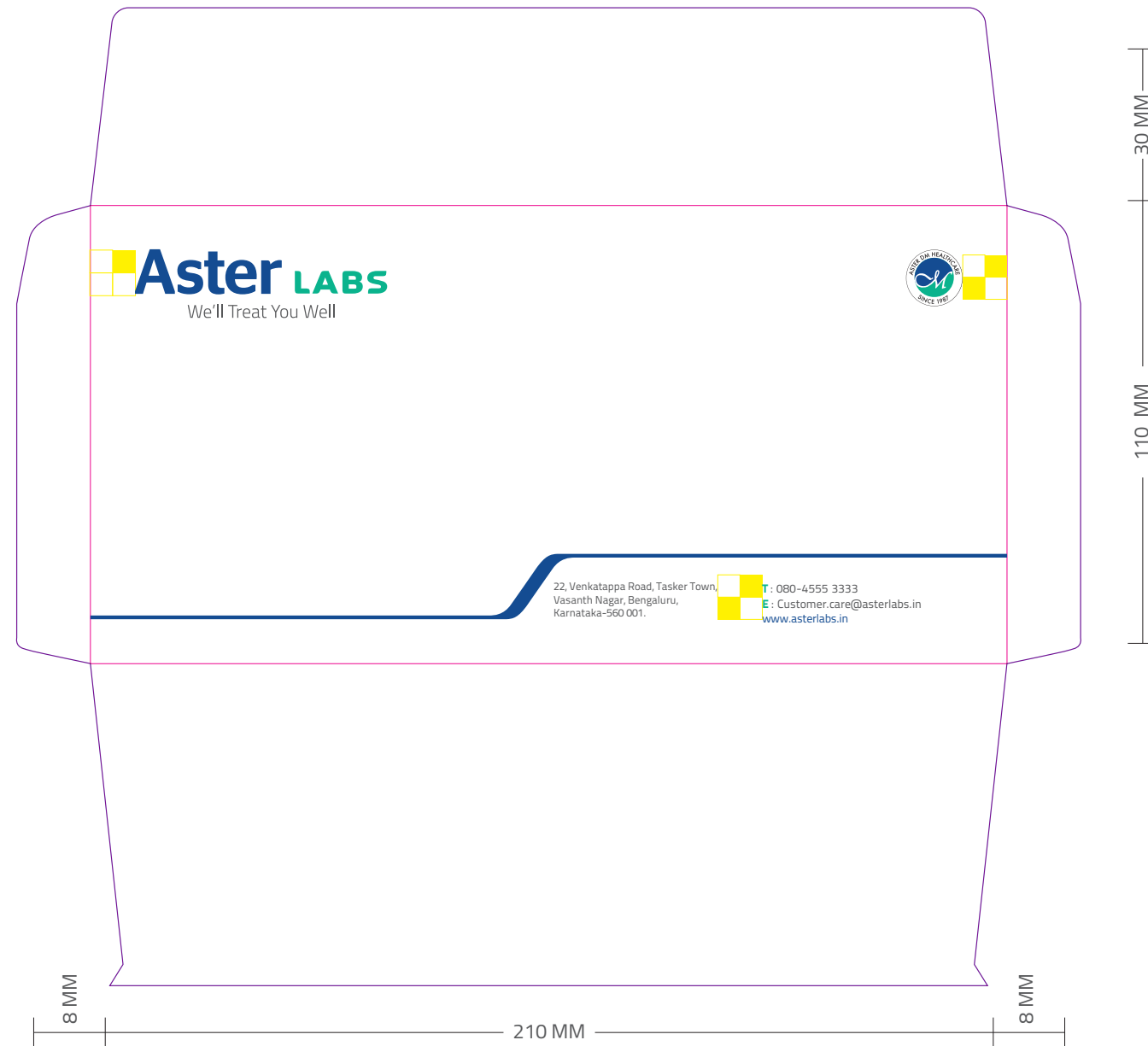

Envelope DL

Specifications: 120 GSM Maplitho

Logo size and position rule

The size and position of the Master Brand Logo on our brand A4 Envelope shown here. It is important to observe the clear-space rule from the top and right-hand edges to ensure clear readability.



Material Specification:

120 GSM Maplitho

STATIONERY

A5 NOTEPAD

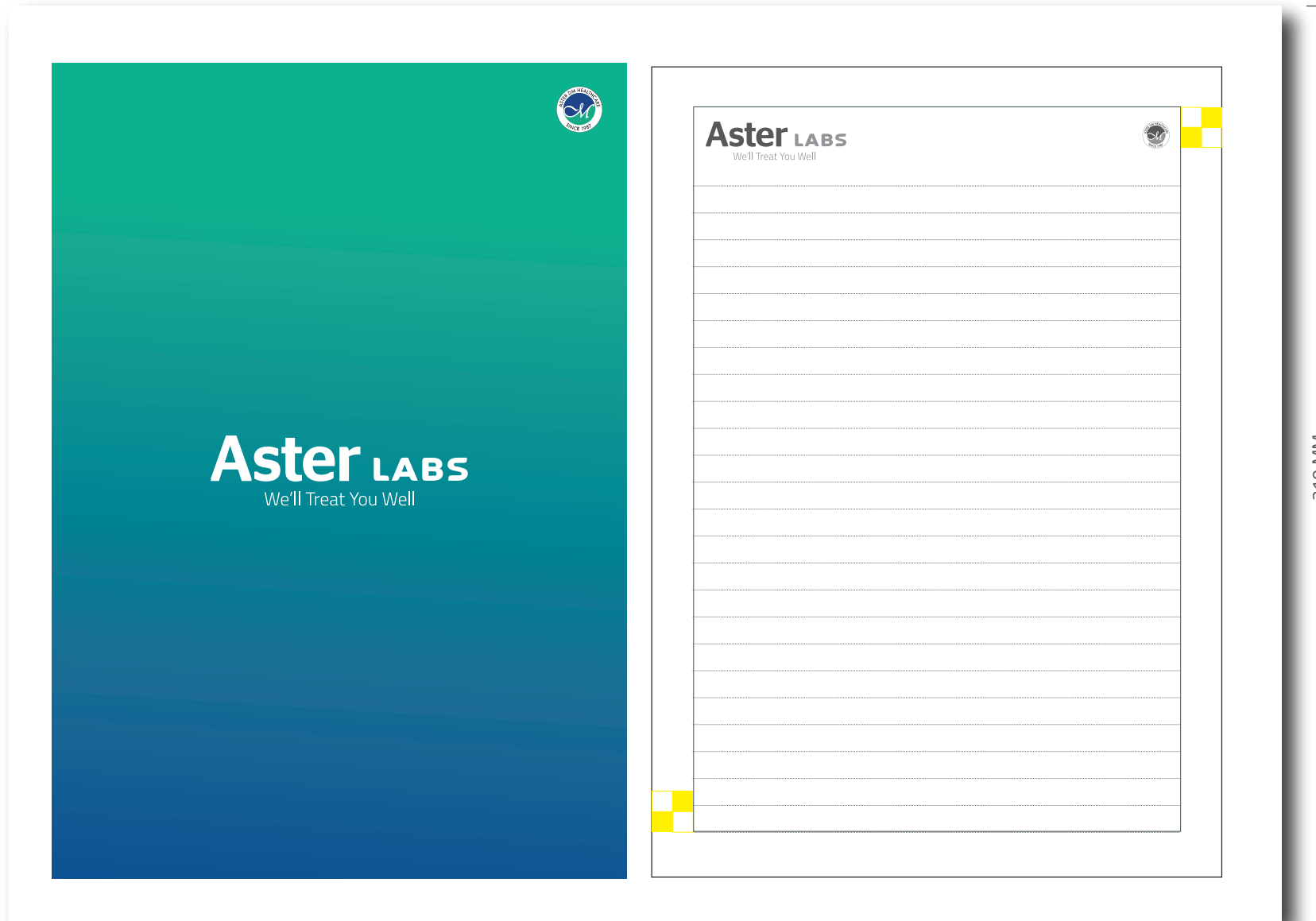

Logo size and position rule

The size and position of the Master Brand Logo on our brand Note pad shown here. It is important to observe the clear-space rule from the top and right-hand edges to ensure clear readability.

Cover

Specifications:

Cover Page – 130 GSM Glossy; Inner Pages – 90 GSM Sunshine Maplitho

Inside

148.5 MM

210 MM

STATIONERY ID CARD

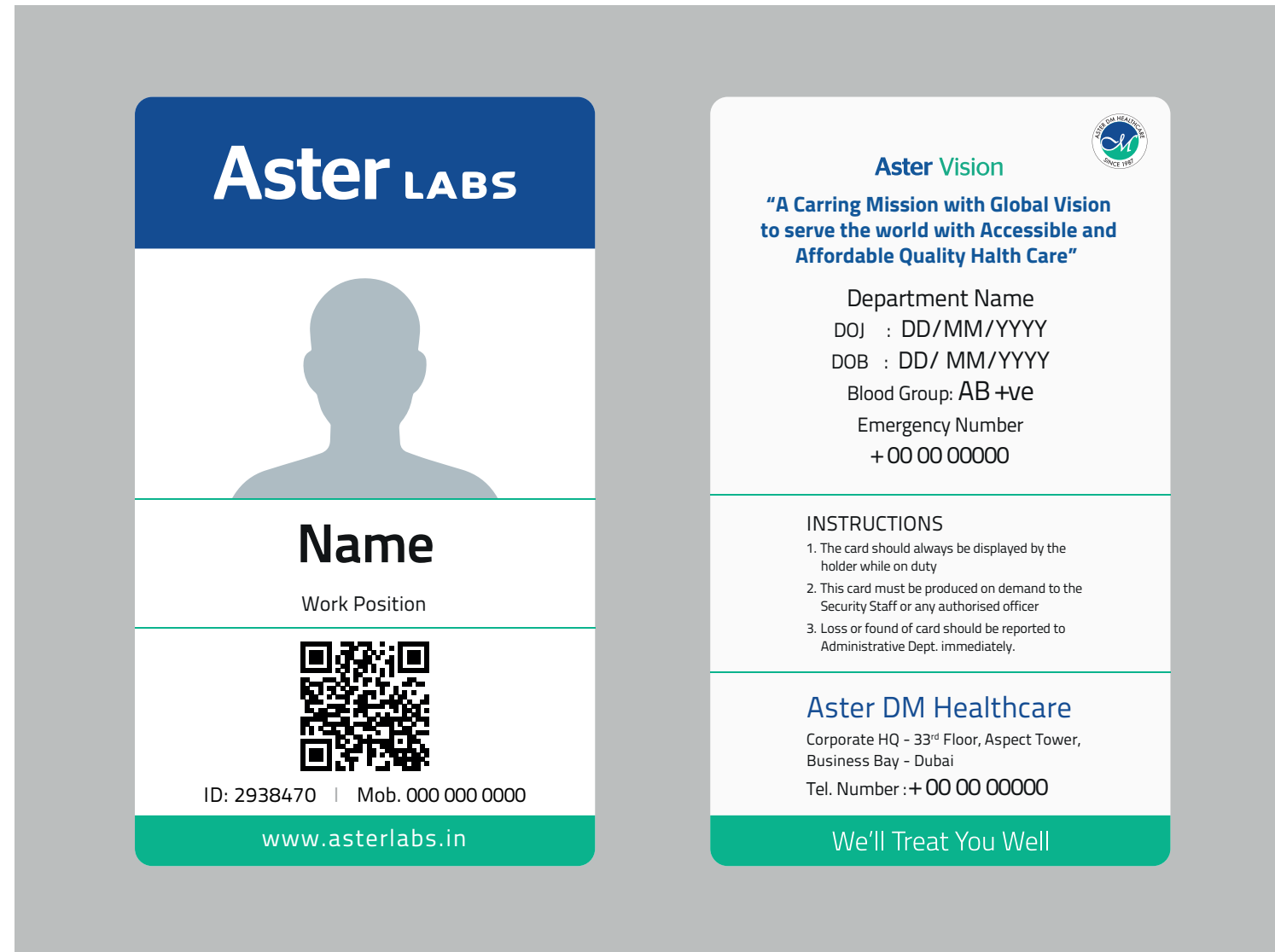

Size: 3.375" x 2.125"
Material: PVC

STATIONERY POWERPOINT TEMPLATE

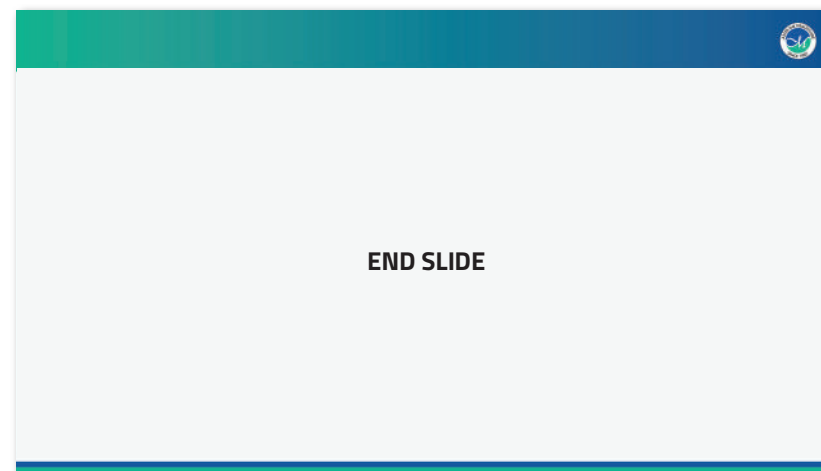
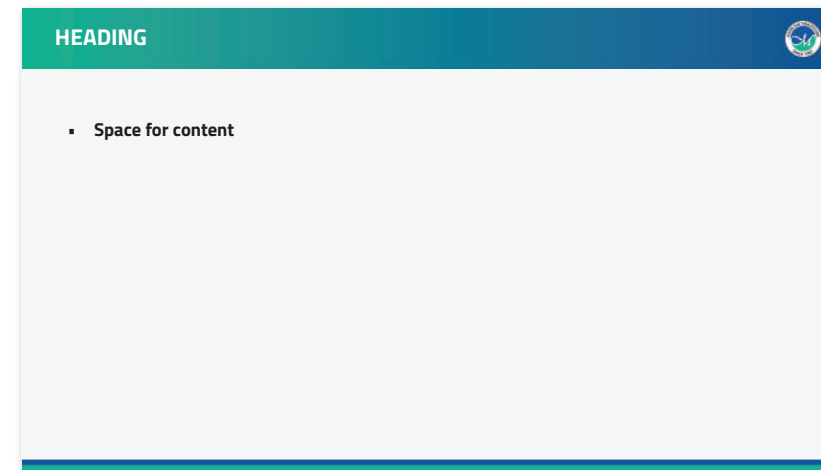

STATIONERY

E-MAIL SIGNATURE TEMPLATE

First Name Last Name

Designation - Department



Aster Labs

No.24, Venkatappa Road, Tasker Town,
Vasanth Nagar, Bengaluru - 560 051.

T: 080 4555 3200/3202 **M:** + 91 0000000000

E: name@asterlabs.in

www.asterlabs.in

Aster LABS

We'll Treat You Well



STATIONERY WALL CLOCK



EVENT/ PRESS CONFERENCE BACKDROP



STATIONERY

CD LABEL



Size: 11.8cm X 11.8cm (CD Cover)

Paper: CD Pouch - 300 GSM matte lamination, CD - Sticker

STATIONERY CD COVER

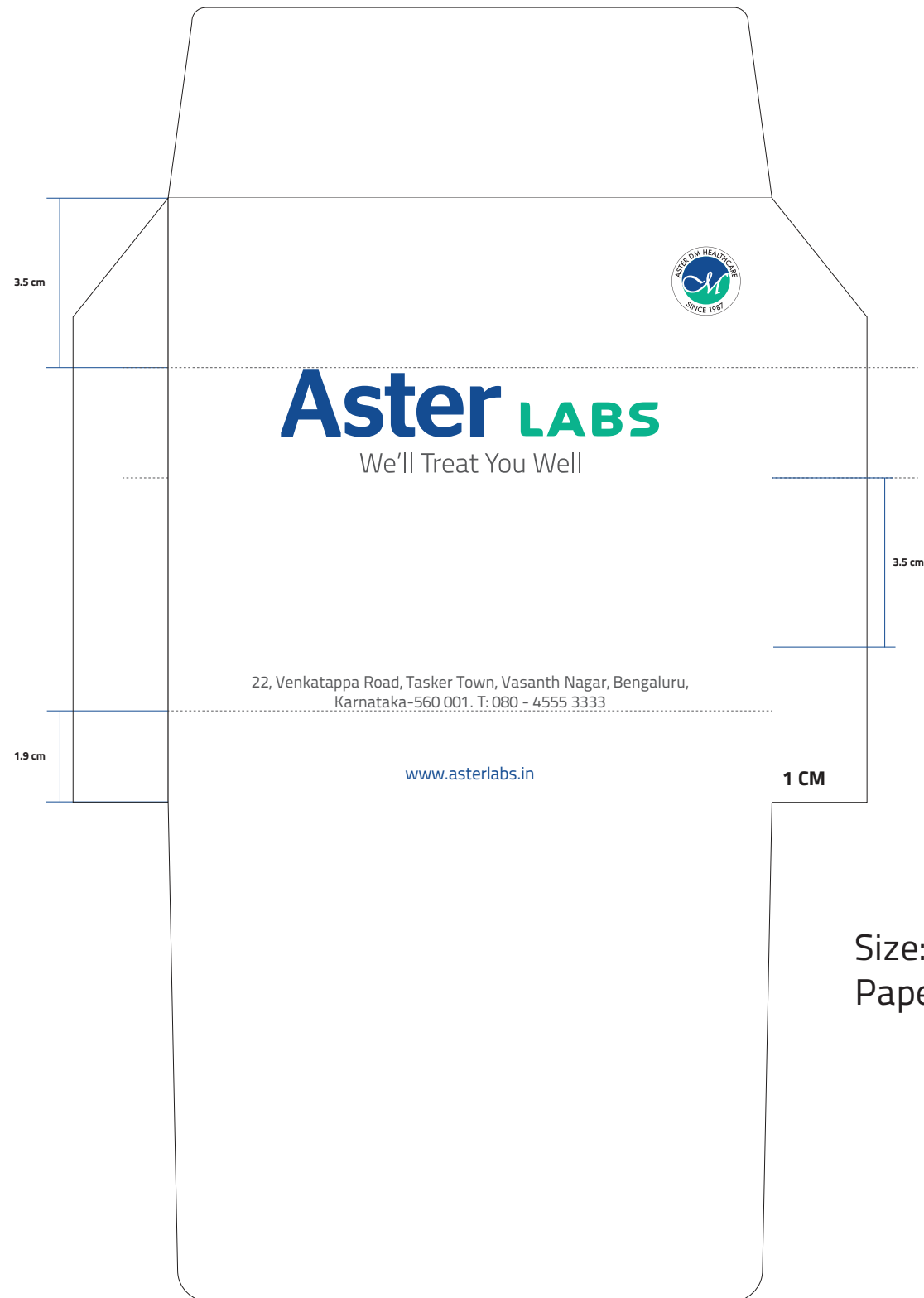

Size: 11.8cm X 11.8cm (CD Cover)
Paper: CD Pouch - 300 GSM matte lamination, CD - Sticker

STATIONERY

A4 TEST REQUISITION FORM



We'll Treat You Well

AL-GF-0001

AFFIX BAR CODE

TEST REQUISITION FORM

PATIENT DEMOGRAPHIC (to be filled in Block Letters)		Specimen collection information:																																																	
First Name: _____		Date of Collection: _____ / _____ / _____																																																	
Middle Name: _____		Time of Collection: _____ A.M. _____ P.M.																																																	
Last Name: _____		Fasting: <input type="checkbox"/> Yes <input type="checkbox"/> No Fasting Period: _____ Hrs.																																																	
Gender: <input type="checkbox"/> Male <input type="checkbox"/> Female <input type="checkbox"/> Transgender <input type="checkbox"/> Others		Collection by: _____ Sign: _____																																																	
DOB: _____		Test Requirement: Please refer to the Directory of Services for correct test code, name and specimen type																																																	
Age: _____ Yrs. _____ months _____ days		Test Code: _____ Test Name: _____ Remarks: _____																																																	
Weight: _____ (kg), Height: _____ (cm), BP: _____ (mm/hg)																																																			
MR/UMID For wellness: -																																																			
<input type="checkbox"/> Exercise <input type="checkbox"/> H/O Tobacco use <input type="checkbox"/> Alcohol use																																																			
<input type="checkbox"/> H/O any chronic disease <input type="checkbox"/> H/O disease																																																			
Mobile No: _____ Email ID: _____																																																			
Address: _____																																																			
Referring Doctor Name: _____ RF Dr Code: _____		Specimen Type																																																	
Mobile Number: _____ City: _____		<table border="1" style="width: 100%; border-collapse: collapse;"> <thead> <tr> <th>Type</th> <th>QTY</th> <th>Type</th> <th>QTY</th> </tr> </thead> <tbody> <tr> <td><input type="checkbox"/> Serum</td> <td></td> <td><input type="checkbox"/> Smear</td> <td></td> </tr> <tr> <td><input type="checkbox"/> Plasma: EDTA/FLY/OT</td> <td></td> <td><input type="checkbox"/> Slide (H & E)</td> <td></td> </tr> <tr> <td><input type="checkbox"/> SST</td> <td></td> <td><input type="checkbox"/> Pus</td> <td></td> </tr> <tr> <td><input type="checkbox"/> Whole Blood EDTA</td> <td></td> <td><input type="checkbox"/> CSF</td> <td></td> </tr> <tr> <td><input type="checkbox"/> Whole Blood Fluoride</td> <td></td> <td><input type="checkbox"/> Fluid</td> <td></td> </tr> <tr> <td><input type="checkbox"/> Whole Blood Heparin</td> <td></td> <td><input type="checkbox"/> BAL</td> <td></td> </tr> <tr> <td><input type="checkbox"/> Whole Blood Sodium Citrate</td> <td></td> <td><input type="checkbox"/> Sputum</td> <td></td> </tr> <tr> <td><input type="checkbox"/> Bone Marrow</td> <td></td> <td><input type="checkbox"/> Urine</td> <td></td> </tr> <tr> <td><input type="checkbox"/> FN Aspirate</td> <td></td> <td><input type="checkbox"/> Stool</td> <td></td> </tr> <tr> <td><input type="checkbox"/> Tissue (Small/MI)</td> <td></td> <td><input type="checkbox"/> Swab</td> <td></td> </tr> <tr> <td><input type="checkbox"/> Paraffin Block</td> <td></td> <td><input type="checkbox"/> Others</td> <td></td> </tr> </tbody> </table>		Type	QTY	Type	QTY	<input type="checkbox"/> Serum		<input type="checkbox"/> Smear		<input type="checkbox"/> Plasma: EDTA/FLY/OT		<input type="checkbox"/> Slide (H & E)		<input type="checkbox"/> SST		<input type="checkbox"/> Pus		<input type="checkbox"/> Whole Blood EDTA		<input type="checkbox"/> CSF		<input type="checkbox"/> Whole Blood Fluoride		<input type="checkbox"/> Fluid		<input type="checkbox"/> Whole Blood Heparin		<input type="checkbox"/> BAL		<input type="checkbox"/> Whole Blood Sodium Citrate		<input type="checkbox"/> Sputum		<input type="checkbox"/> Bone Marrow		<input type="checkbox"/> Urine		<input type="checkbox"/> FN Aspirate		<input type="checkbox"/> Stool		<input type="checkbox"/> Tissue (Small/MI)		<input type="checkbox"/> Swab		<input type="checkbox"/> Paraffin Block		<input type="checkbox"/> Others	
Type	QTY	Type	QTY																																																
<input type="checkbox"/> Serum		<input type="checkbox"/> Smear																																																	
<input type="checkbox"/> Plasma: EDTA/FLY/OT		<input type="checkbox"/> Slide (H & E)																																																	
<input type="checkbox"/> SST		<input type="checkbox"/> Pus																																																	
<input type="checkbox"/> Whole Blood EDTA		<input type="checkbox"/> CSF																																																	
<input type="checkbox"/> Whole Blood Fluoride		<input type="checkbox"/> Fluid																																																	
<input type="checkbox"/> Whole Blood Heparin		<input type="checkbox"/> BAL																																																	
<input type="checkbox"/> Whole Blood Sodium Citrate		<input type="checkbox"/> Sputum																																																	
<input type="checkbox"/> Bone Marrow		<input type="checkbox"/> Urine																																																	
<input type="checkbox"/> FN Aspirate		<input type="checkbox"/> Stool																																																	
<input type="checkbox"/> Tissue (Small/MI)		<input type="checkbox"/> Swab																																																	
<input type="checkbox"/> Paraffin Block		<input type="checkbox"/> Others																																																	
Code: _____ Name: _____		Sample Type: _____ Urine Collection Volume: _____ ML _____ Hrs																																																	
Address and Seal: _____		Essential Clinical Information (Please Fill in whatever is relevant)																																																	
Phone: _____		1. Provisional diagnosis: _____																																																	
Email ID: _____		2. H/O medication: <input type="checkbox"/> Yes <input type="checkbox"/> No																																																	
For <input type="checkbox"/> Repeat <input type="checkbox"/> Follow-up Patients		3. Status of Medication: <input type="checkbox"/> On going <input type="checkbox"/> Terminated																																																	
AL Bar Code No: _____		4. LMP (Where applicable): _____																																																	
Date: _____		5. Diabetes Status: <input type="checkbox"/> Yes <input type="checkbox"/> No																																																	
		6. Attached other relevant information: _____																																																	
		7. Gestation: _____																																																	
		<input type="checkbox"/> Single <input type="checkbox"/> Twins <input type="checkbox"/> Others																																																	
In case of certain tests (Example: Prenatal test, Maternal screening, IHCs), specific TRPs and supporting documents are required as mentioned in DoS. These should be filled completely and provided to avoid sample rejection and reporting delays																																																			
Shipment Temperature (to be filled by sender)		Receiving Temperature (to be filled by AL)																																																	
<input type="checkbox"/> Room Temperature (Ambient)		<input type="checkbox"/> Room Temperature (Ambient)																																																	
<input type="checkbox"/> Refrigerated (2-8° C)		<input type="checkbox"/> Refrigerated (2-8° C)																																																	
<input type="checkbox"/> Frozen (-20 °C)		<input type="checkbox"/> Frozen (-20 °C)																																																	
Patient Consent: I hereby authorize Aster Clinical Lab LLP to use my personal information to provide me with the services and products of my request, to assist me about my question about those services, billing and payment methods, to process or collect payment made in connection with the services to me and to evaluate the services and products and to conduct customer surveys. I further hereby authorize and consent to Aster Clinical Lab LLP to collect, use, process, share with affiliates and contacted third parties, the information including but not limited to my condition /disease information, including diagnosis date, first symptom information, and family history, biographical information, including bio, gender, age, location, general notes and details of test sought from Aster Clinical Lab LLP, as may be necessary to perform the test.																																																			
Date: _____		Patient/Guardian/Doctor's Signature: _____																																																	
Signature of Client / CC/PUP/ Hospitals/ PEC: _____		Date: _____																																																	
Note: It is Mandatory to provide all the requested information to enable accurate and timely reporting.																																																			

24, Venkatappa Road, Tasker Town, Vasanth Nagar, Bengaluru-560 001. T: 080 4555 3302



We'll Treat You Well

AL-GF-0001

AFFIX BAR CODE

TEST CODE	TEST NAME	TEST CODE	TEST NAME	TEST CODE	TEST NAME
PROFILES					
<input type="checkbox"/> L0053	LIPID PROFILE, BASIC	<input type="checkbox"/> P0074	POTASSIUM, SERUM	<input type="checkbox"/> D0001	D-DIMER, QUANTITATIVE
<input type="checkbox"/> T0038	THYROID PROFILE, TOTAL	<input type="checkbox"/> C0388	CHLORIDE, SERUM	<input type="checkbox"/> L0006	LDH, LACTATE
<input type="checkbox"/> L0044	LIVER FUNCTION TEST LFT	<input type="checkbox"/> M0006	MAGNESIUM, SERUM	<input type="checkbox"/> C0090	CHOLESTEROL, TOTAL
<input type="checkbox"/> K0012	KIDNEY FUNCTION TEST KFT	<input type="checkbox"/> B0031	BICARBONATE, SERUM	<input type="checkbox"/> F0166	FREE THYROXINE (FT4)
<input type="checkbox"/> G0053	GLUCOSE, FASTING (F) AND POST MEAL (PP), 2 HOURS	<input type="checkbox"/> A0037	ALBUMIN, SERUM	<input type="checkbox"/> B0049	BLOOD PICTURE PERIPHERAL BLOOD SMEAR EXAMINATION IMMUNOGLOBULIN IgE, SERUM
<input type="checkbox"/> A0193	*FSH *LH *Prolactin	<input type="checkbox"/> U0010	UREA, SERUM	<input type="checkbox"/> I0026	BLOOD GROUP ABO & RH FACTOR
HAEMATOLOGY					
<input type="checkbox"/> H0095	HAEMOGLOBIN HEMOGRAM (CBC & ESR)	<input type="checkbox"/> E0017	ELECTROLYTES, SERUM	<input type="checkbox"/> I0230	INTERLEUKIN - 6
<input type="checkbox"/> P0064	PLATELET COUNT	<input type="checkbox"/> E0244	IRON STUDIES	<input type="checkbox"/> P0112	PSA (PROSTATE - SPECIFIC ANTIGEN), TOTAL
<input type="checkbox"/> C0058	CBC COMPLETE BLOOD COUNT	<input type="checkbox"/> A0283	ANTI-THYROID PEROXIDASE ANTIBODY	<input type="checkbox"/> R0028	RHEUMATOID FACTOR (RA) SERUM
<input type="checkbox"/> E0039	ERYTHROCYTE SEDIMENTATION RATE (ESR)	<input type="checkbox"/> A0281	ANTI-THYROGLOBULIN ANTIBODY	<input type="checkbox"/> T0079	TRIGLYCERIDES, SERUM
<input type="checkbox"/> M0130	MALARIA QBC	<input type="checkbox"/> A0256	ANTI-CYCLIC CITRULLINATED PEPTIDE	MICROBIOLOGY	
<input type="checkbox"/> P0110	PROTHROMBIN TIME STUDIES	<input type="checkbox"/> C0185	CPK	<input type="checkbox"/> C0247	URINE C/S
<input type="checkbox"/> A0014	ACTIVATED PARTIAL THROMBOPLASTIN TIME	<input type="checkbox"/> E0041	ESTRADIOL (E2), SERUM	<input type="checkbox"/> C0246	STOOL C/S
<input type="checkbox"/> C0157	COOMBS TEST, INDIRECT	<input type="checkbox"/> B0025	BETA HCG, TOTAL, QUANTITATIVE, MATERNAL	<input type="checkbox"/> C0225	SPUTUM C/S
<input type="checkbox"/> C0156	COOMBS TEST, DIRECT	<input type="checkbox"/> F0025	FERRITIN	<input type="checkbox"/> C0224	SEMEN C/S
<input type="checkbox"/> M0008	MALARIA PARASITE/ BLOOD PARASITE IDENTIFICATION	<input type="checkbox"/> F0156	FOLATE (FOLIC ACID), SERUM	<input type="checkbox"/> C0223	PUS C/S
BIOCHEMISTRY					
<input type="checkbox"/> G0052	GLUCOSE, FASTING (F)	SEROLOGY		CLINICAL PATHOLOGY	
<input type="checkbox"/> G0095	GLUCOSE, POST PRANDIAL (PP), 2 HOURS	<input type="checkbox"/> H0251	HBSAG RAPID TEST	<input type="checkbox"/> U0015	URINE EXAMINATION, ROUTINE
<input type="checkbox"/> G0056	GLUCOSE, RANDOM (R)	<input type="checkbox"/> H0252	HCV RAPID TEST	<input type="checkbox"/> P0078	URINE FOR PREGNANCY
<input type="checkbox"/> G0060	GLYCOSYLATED HAEMOGLOBIN (HBA1C)	<input type="checkbox"/> H0250	HIV SCREENING TEST RAPID	<input type="checkbox"/> S0074	STOOL OCCULT
<input type="checkbox"/> T0006	T3 & T4, TOTAL	<input type="checkbox"/> D0058	DENGUE RAPID CARD	<input type="checkbox"/> S0075	STOOL ROUTINE
<input type="checkbox"/> T0007	T3 (TRIMODOTHYRONINE), SERUM	<input type="checkbox"/> Q0002	QUANTIFERON-TB GOLD GAMMA INTERFERON	<input type="checkbox"/> S0014	SEMEN ANALYSIS
<input type="checkbox"/> T0011	T4 (THYROXINE), SERUM	<input type="checkbox"/> G0035	GENEXPERT MTB WITH RIFAMPICIN RESISTANCE, QUALITATIVE, PCR	FLUID ANALYSIS/CYTOLOGY	
<input type="checkbox"/> T0086	TSH (THYROID STIMULATING HORMONE)	<input type="checkbox"/> V0011	VDRL (RPR) SERUM	<input type="checkbox"/> P0057	PLEURAL FLUID ANALYSIS
<input type="checkbox"/> B0034	BILIRUBIN TOTAL, DIRECT & INDIRECT	OTHER INVESTIGATION		<input type="checkbox"/> A0301	ASCITIC FLUID ANALYSIS
<input type="checkbox"/> S0020	SGOT, ASPARTATE AMINOTRANSFERASE (AST)	<input type="checkbox"/> V0021	VITAMIN B12	<input type="checkbox"/> S0085	SYNOVIAL FLUID ANALYSIS
<input type="checkbox"/> S0021	SGPT, ALANINE AMINOTRANSFERASE (ALT)	<input type="checkbox"/> V0030	VITAMIN D 25 - HYDROXY	<input type="checkbox"/> A0021	ADENOSINE DEAMINASE, BODY FLUIDS
<input type="checkbox"/> C0198	CREATININE, SERUM	<input type="checkbox"/> M0022	MATERNAL DUAL MARKER (11 TO 13 WEEKS)	CYTOLOGY	
<input type="checkbox"/> C0030	CALCIUM, SERUM	<input type="checkbox"/> M0023	MATERNAL QUADRUPLE MARKER (14 TO 20 WEEKS)	<input type="checkbox"/> C0293	PAP SMEAR
<input type="checkbox"/> S0051	SODIUM, SERUM	<input type="checkbox"/> M0024	SGOT, ASPARTATE AMINOTRANSFERASE (AST)	<input type="checkbox"/> C0292	LBC
		<input type="checkbox"/> P0090	PROLACTIN, SERUM	<input type="checkbox"/> F0037	FNAC
		<input type="checkbox"/> A0264	ANTI-MULLERIAN HORMONE	WELLNESS PACKAGE	
		<input type="checkbox"/> F0157	FOLLICLE STIMULATING HORMONE FSH	<input type="checkbox"/> T0095	TRUE TEST SCREEN
		<input type="checkbox"/> L0070	LUTEINISING HORMONE LH	<input type="checkbox"/> T0097	TRUE TEST SHIELD
		<input type="checkbox"/> C0190	C-REACTIVE PROTEIN, CRP	<input type="checkbox"/> T0098	TRUE TEST SECURE
				<input type="checkbox"/> T0099	TRUE TEST SAFEGUARD

STATIONERY

A4 REPORT SHEET

Aster LABS
We'll Treat You Well



TEST REPORT

Reg. No :	Reg. Date :	Collection :
Name :		Received :
Age :	Sex :	Report :
Referred By :		Printed :
Referral Dr :		Location :
Lab ID :		

22, Venkatappa Road, Tasker Town, Vasanth Nagar, Bengaluru, Karnataka-560 001. T : 080-4555 3333 www.asterlabs.in

STATIONERY PARKING STICKER

3 inch



3 inch



SIGNAGES

External Signage	36
Internal Signage	37
Internal Wall Branding	38
Reception Table	39

EXTERNAL SIGNAGE



①

3D INDIVIDUAL LETTERS MADE OF 2.8MM ALUMINUM SHEET POWDER COATED SHOULD MATCH THE PANTONE 294 C 60MM 3D EMBOSSED LETTERS (ACRYLIC COLTOR REFMODEN GLAS M327 BLUE CAST ACRYLIC) FACE LIT LETTERS (6000K LED STRIPS)

②

②

3D INDIVIDUAL LETTERS MADE OF 2.8MM ALUMINUM SHEET POWDER COATED SHOULD MATCH THE PANTONE 339 C 60MM 3D EMBOSSED OPAL WHITE ACRYLIC LETTERS WITH VINYL FASCIA (VINYL RE.: AF.: AVERY 4539 TF TURQUOISE) FACE LIT LETTERS (6000K LED STRIPS) OPAL WHITE ACRYLIC LETTERS WITH VINYL FASCIA (VINYL RE.: AF.: AVERY 4539 TF TURQUOISE) FACE LIT LETTERS (6000K LED STRIPS)

③

Aster DM Healthcare-3D 2.8MM ALUMINUM SHEET WHITE POWDER COATED ROUND LOGO PRINTED ON LIGHT PASS VINYL AND UV LAMINATION MOUNTED ON 60MM OPAL WHITE ACRYLIC GRAPHICS PRINTED SHOULD MATCH THE BELOW COLORS: BLUE COLOR SHOULD MATCH BLUE VINYL REF AVERY 4517 TF DARK BLUE (REF: 375623) GREEN COLOR SHOULD

SPECIAL NOTE:

FOR THE SIGN LETTERS WHICH ARE LESS THAN 1 METER HEIGHT SHOULD BE THE DEPTH OF 60MM AND SIGN LETTERS WHICH ARE MORE THAN 1 METER AND LESS THAN 2METER SHOULD BETHE DEPTH OF 100MM

INTERNAL SIGNAGES



Restricted Entry
ಪ್ರವೇಶ ನಿರ್ಬಂಧಿಸಲಾಗಿದೆ



Laboratory
ಲ್ಯಾಬೋರೇಟರಿ



Phlebotomy
ಫ್ಲೆಬೋಟಮಿ



Consultation
ಸಮಾಲೋಚನೆ

Material Specification:

Aluminium modular profile signage (Belgium Made available across the globe) with Acrylic board for Facia and high quality 3M Vinyl printed on UV platform.

INTERNAL WALL BRANDING



We'll Treat You Well

WE'LL TREAT YOU WITH THE LATEST TECHNOLOGIES,
HIGHEST STANDARDS OF QUALITY,
MAXIMUM PRECISION,
MINIMUM HUMAN ERROR.
WE'LL TREAT YOU WITH THE CARE YOU DESERVE.

www.asterlabs.in

Aster LABS
We'll Treat You Well

RECEPTION

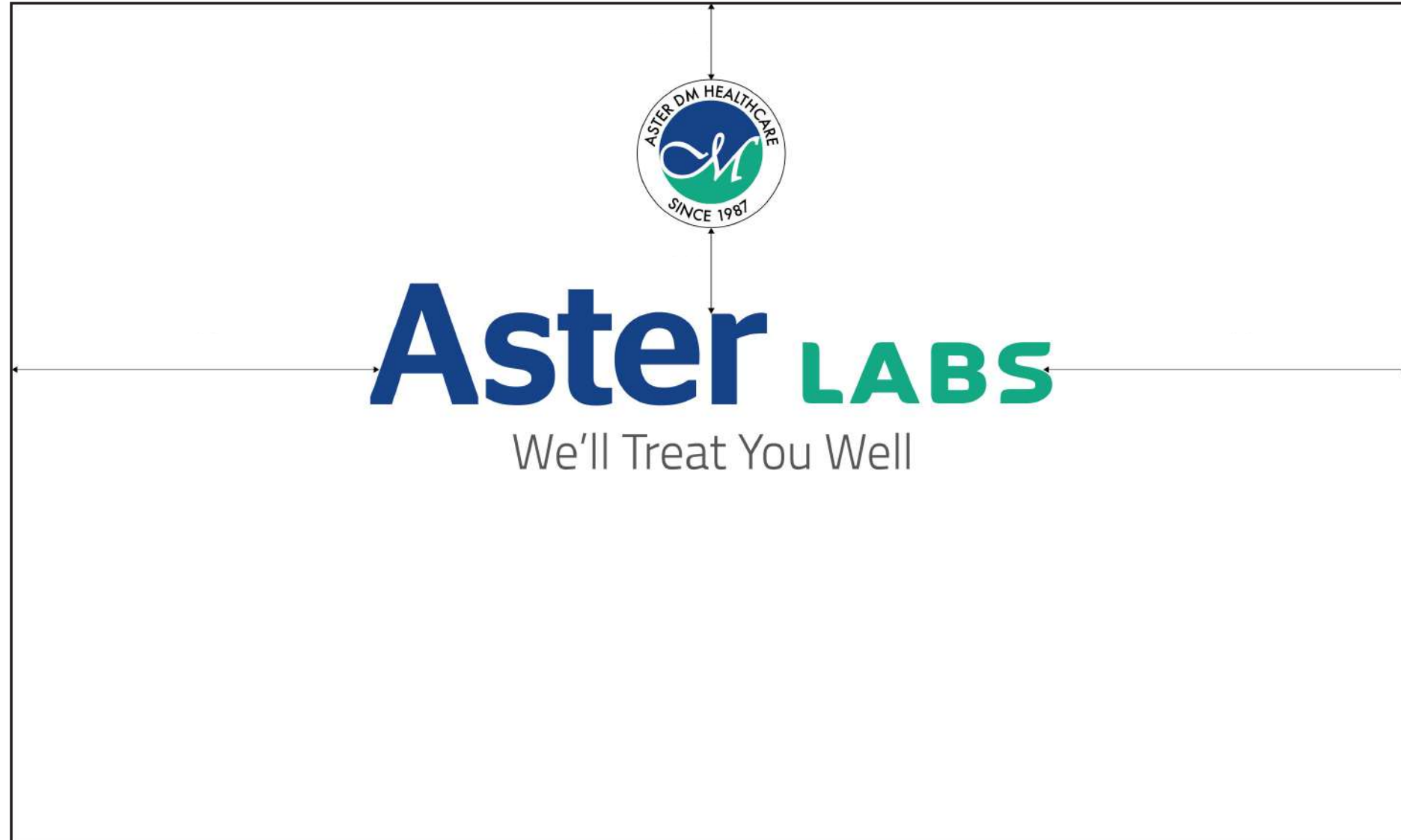

MARKETING & ADVERTISING COLLATERALS

Flyer/Newspaper Insert	40
Banner	41
Poster	42
Easel	43
Standee	44
Newspaper Ads	45
Hoardings - Horizontal	46
Hoarding - Vertical	47
Hoarding - Square	48
Road Median	49

FLYER/NEWSPAPER INSERT



OVER 2500 TESTS AND MORE.
ASTER LABS LAUNCHES
IN VASHI.
COME, TEST US.

FLAT 20% OFF*
ON ALL SERVICES
FOR WALK-INS

FREE
HOME COLLECTION
ON ALL INVESTIGATIONS*

LIMITED PERIOD OFFER

TEST FROM HOME
For Home Collection
Call: 96803 96803

Aster LABS
We'll Treat You Well

Visit www.asterlabs.in, Plot No. 39, Sector-19 E, Behind Furniture
Mall Vashi, Navi Mumbai-400 705. T: 022-2783 0003

7 Countries | 27 Hospitals | 118 Clinics | 323 Pharmacies | 100 Labs

210 MM

148.5 MM

*T&C Apply

BANNER



*T&C Apply.



TRUE TEST SAFEGUARD
74 TESTS AT ₹ 1799*

LIMITED PERIOD OFFER

TEST FROM HOME For Home Collection Call:
96803 96803

Aster LABS
We'll Treat You Well

Follow us: [f](#) [t](#) [v](#) [in](#) [i](#)

5 FEET

3 FEET

POSTER



OVER 2500 TESTS AND MORE.
ASTER LABS LAUNCHES
IN VASHI.
COME, TEST US.

FLAT 20% OFF*
ON ALL SERVICES
FOR WALK-INS

FREE
HOME COLLECTION
ON ALL INVESTIGATIONS*

LIMITED PERIOD OFFER

TEST FROM HOME
For Home Collection
Call: 96803 96803

Aster LABS
We'll Treat You Well

Visit www.asterlabs.in, Plot No. 39, Sector-19 E, Behind Furniture
Mall Vashi, Navi Mumbai-400 705. T: 022-2783 0003

7 Countries | 27 Hospitals | 118 Clinics | 323 Pharmacies | 100 Labs

*T&C Apply.

420 MM



297 MM





3ft

COME, TEST US.

**ASTER LABS NOW IN VASHI,
NAVI MUMBAI**

Aster Labs is in your city. But before we test you, it's only fair that you test us first. Come, discover everything you'd like to know about what makes Aster the chosen name in healthcare for over 11 lakh customers worldwide.

 <p>20,000 trained professionals including 3000 doctors and 6000 nurses</p>	 <p>Accuracy - Latest technology with minimal human intervention</p>
 <p>Over 2500 tests and wellness packages</p>	 <p>Transparency- barcode tracking of samples from registration onwards</p>
 <p>Home sample collection for all lab tests including RTPCR</p>	



Free Report Interpretation by Expert Pathologist



TEST FROM HOME

For Home Collection
96803 96803
www.asterlabs.in

Plot No. 39, Sector-19 E,
Behind Furniture Mall Vashi,
Navi Mumbai-400 705.
T: 022-2783 0003

Aster LABS

We'll Treat You Well

UAE | Saudi Arabia | Qatar | Oman | Bahrain | Jordan | India 7 Countries | 27 Hospitals | 118 Clinics | 323 Pharmacies | 100 Labs

4ft

43

STANDEE



FLAT 20% OFF*
ON ALL SERVICES
FOR WALK-INS





FREE
HOME COLLECTION
ON ALL INVESTIGATIONS*

LIMITED PERIOD OFFER

TEST FROM HOME  **For Home Collection Call:
96803 96803**

 Opt for a report interpretation
by our expert pathologist
at no additional charge.

Aster LABS
We'll Treat You Well

Follow us:     

7 Countries | 27 Hospitals | 118 Clinics | 323 Pharmacies | 100 Labs

*T&C Apply.

6 Feet

3 Feet

NEWSPAPER ADS

COME, TEST US.

ASTER LABS IS NOW IN VASHI, NAVI MUMBAI

Aster Labs is in your city. But before we test you, it's only fair that you test us first. Come, discover everything you'd like to know about what makes Aster the chosen name in healthcare for over 11 lakh customers worldwide.

- 20,000 trained professionals including 3000 doctors and 6000 nurses
- Over 2500 tests and wellness packages
- Accuracy - Latest technology with minimal human intervention
- Transparency- barcode tracking of samples from registration onwards
- Home sample collection for all lab tests including RTPCR

Free Report Interpretation by Expert Pathologist

TEST FROM HOME For Home Collection **96803 96803** www.asterlabs.in

Plot No. 39, Sector-19 E, Behind Furniture Mall Vashi, Navi Mumbai-400 705. T: 022-2783 0003

Aster LABS
We'll Treat You Well

UAE | Saudi Arabia | Qatar | Oman | Bahrain | Jordan | India 7 Countries | 27 Hospitals | 118 Clinics | 323 Pharmacies* | 100 Labs

Half Page Ad

COME, TEST US.

ASTER LABS NOW IN VASHI, NAVI MUMBAI

Aster Labs is in your city. But before we test you, it's only fair that you test us first. Come, discover everything you'd like to know about what makes Aster the chosen name in healthcare for over 11 lakh customers worldwide.

- 20,000 trained professionals including 3000 doctors and 6000 nurses
- Over 2500 tests and wellness packages
- Accuracy - Latest technology with minimal human intervention
- Transparency- barcode tracking of samples from registration onwards
- Home sample collection for all lab tests including RTPCR

Free Report Interpretation by Expert Pathologist

TEST FROM HOME For Home Collection **96803 96803** www.asterlabs.in

Plot No. 39, Sector-19 E, Behind Furniture Mall Vashi, Navi Mumbai-400 705. T: 022-2783 0003

Aster LABS
We'll Treat You Well

UAE | Saudi Arabia | Qatar | Oman | Bahrain | Jordan | India 7 Countries | 27 Hospitals | 118 Clinics | 323 Pharmacies* | 100 Labs

Quarter Page Ad

HOARDING HORIZONTAL

COME, TEST US.

ASTER LABS NOW IN VASHI, NAVI MUMBAI

Aster Labs is in your city. But before we test you, it's only fair that you test us first. Come, discover everything you'd like to know about what makes Aster the chosen name in healthcare for over 11 lakh customers worldwide.

- 20,000 trained professionals including 3000 doctors and 6000 nurses
- Accuracy - Latest technology with minimal human intervention
- Home sample collection for all lab tests including RTPCR
- Over 2500 tests and wellness packages
- Transparency- barcode tracking of samples from registration onwards
- Free Report Interpretation by Expert Pathologist**

TEST FROM HOME For Home Collection **96803 96803**
www.asterlabs.in

Plot No. 39, Sector-19 E,
Behind Furniture Mall Vashi,
Navi Mumbai-400 705.
T: 022-2783 0003

Aster LABS
We'll Treat You Well

UAE | Saudi Arabia | Qatar | Oman | Bahrain | Jordan | India

7 Countries | 27 Hospitals | 118 Clinics | 323 Pharmacies | 100 Labs

HOARDING VERTICAL



**COME,
TEST US.**

**ASTER LABS NOW IN VASHI,
NAVI MUMBAI**

Aster Labs is in your city. But before we test you, it's only fair that you test us first. Come, discover everything you'd like to know about what makes Aster the chosen name in healthcare for over 11 lakh customers worldwide.

-  20,000 trained professionals including 3000 doctors and 6000 nurses
-  Accuracy - Latest technology with minimal human intervention
-  Over 2500 tests and wellness packages
-  Transparency- barcode tracking of samples from registration onwards
-  Home sample collection for all lab tests including RTPCR
-  **Free Report Interpretation by Expert Pathologist**
-  **TEST FROM HOME**
- For Home Collection **96803 96803**
www.asterlabs.in
- Plot No. 39, Sector-19 E,
Behind Furniture Mall Vashi,
Navi Mumbai-400 705,
T. 022-2783 0003

Aster LABS
We'll Treat You Well

UAE | Saudi Arabia | Qatar | Oman | Bahrain | Jordan | India | 7 Countries | 27 Hospitals | 118 Clinics | 323 Pharmacies | 100 Labs

HOARDING SQUARE



COME, TEST US.

ASTER LABS NOW IN VASHI, NAVI MUMBAI

Aster Labs is in your city. But before we test you, it's only fair that you test us first. Come, discover everything you'd like to know about what makes Aster the chosen name in healthcare for over 11 lakh customers worldwide.



-  20,000 trained professionals including 3000 doctors and 6000 nurses
-  Accuracy - Latest technology with minimal human intervention
-  Home sample collection for all lab tests including RTPCR
-  Over 2500 tests and wellness packages
-  Transparency- barcode tracking of samples from registration onwards

 **Free Report Interpretation by Expert Pathologist**

 **TEST FROM HOME** For Home Collection **96803 96803** www.asterlabs.in

Plot No. 39, Sector-19 E,
Behind Furniture Mall Vashi,
Navi Mumbai-400 705.
T: 022-2783 0003

Aster LABS
We'll Treat You Well

UAE | Saudi Arabia | Qatar | Oman | Bahrain | Jordan | India

7 Countries | 27 Hospitals | 118 Clinics | 323 Pharmacies | 100 Labs

ROAD MEDIAN



**COME,
TEST US.**

**ASTER LABS NOW IN VASHI,
NAVI MUMBAI**

Aster Labs is in your city. But before we test you, it's only fair that you test us first. Come, discover everything you'd like to know about what makes Aster the chosen name in healthcare for over 11 lakh customers worldwide.

-  20,000 trained professionals including 3000 doctors and 6000 nurses
-  Accuracy - Latest technology with minimal human intervention
-  Over 2500 tests and wellness packages
-  Transparency- barcode tracking of samples from registration onwards
-  Home sample collection for all lab tests including RTPCR
-  Free Report Interpretation by Expert Pathologist
-  TEST FROM HOME
- For Home Collection **96803 96803**
www.asterlabs.in
- Plot No. 39, Sector-19 E,
Behind Furniture Mall Vashi,
Navi Mumbai-400 705.
T: 022-2783 0003

Aster LABS
We'll Treat You Well

UAE | Saudi Arabia | Qatar | Oman | Bahrain | Jordan | India 7 Countries | 27 Hospitals | 110 Clinics | 323 Pharmacies | 100 Labs

UNIFORM

Doctor's / Phlebotomist Apron	50
Customer Relations -Male	51
Customer Relations- Female	52
T-Shirt	53
Home Collection Bag	54
Name tag	55
Badge	56
Shoes	57

UNIFORM

DOCTOR'S / PHLEBOTOMIST APRON

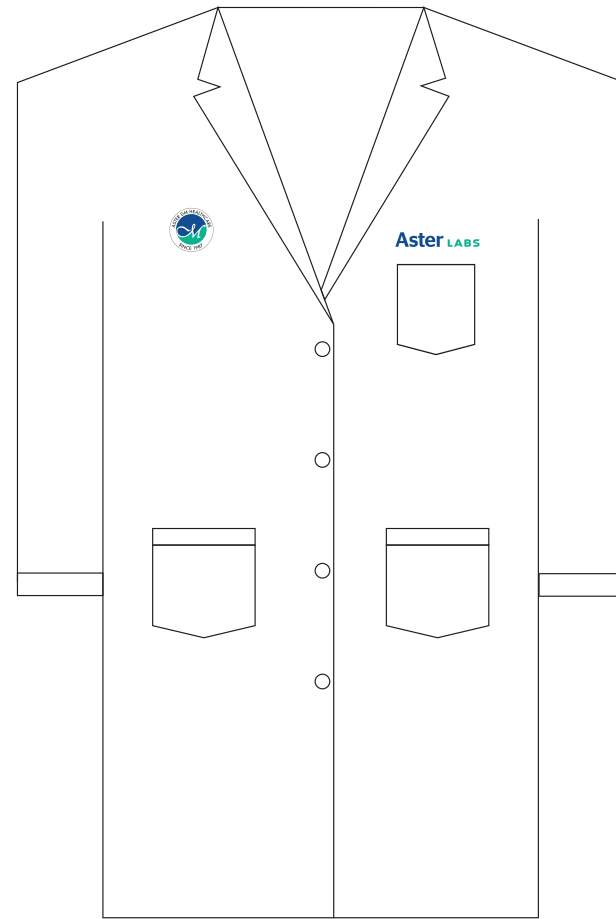

Gabardine Fabric White 65% polyester & 35% cotton

Logo



3 x 3 cm

Aster LABS



Vertical Logo
2 cm H

UNIFORM - MALE

CUSTOMER RELATIONS

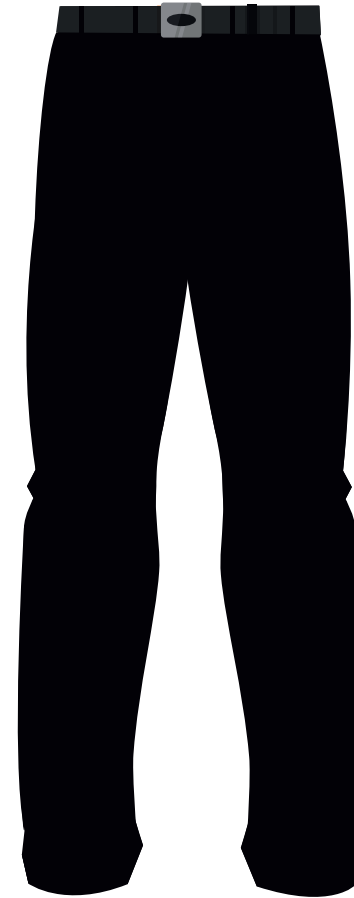
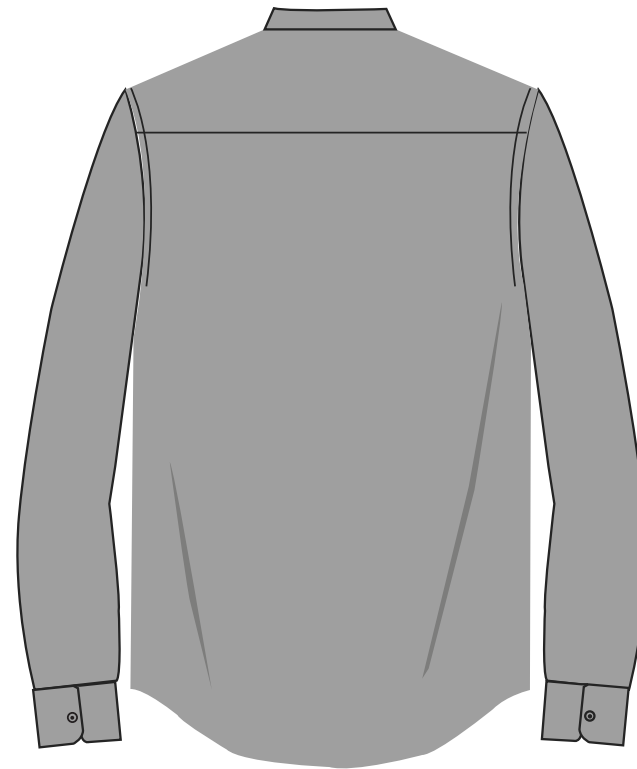

UNIFORM - FEMALE

CUSTOMER RELATIONS

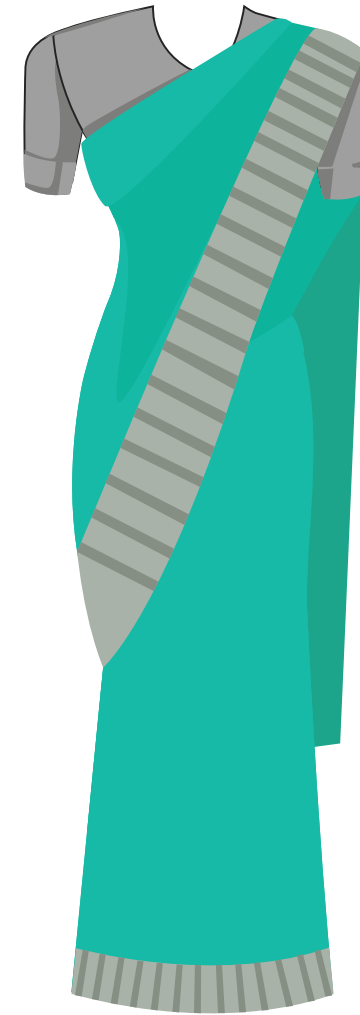

UNIFORM T-SHIRT



UNIFORM

HOME COLLECTION BAG



**UNIFORM
NAME TAG**

Shefali Vats
Customer Relations

Size- 70 mm*25 mm, Metal Badge with UV printing

UNIFORM BADGE



UNIFORM SHOES



Aster LABS

We'll Treat You Well

Can logos
feel
offended?



Not directly, but they
can give your brand the
silent treatment if you
misuse them.

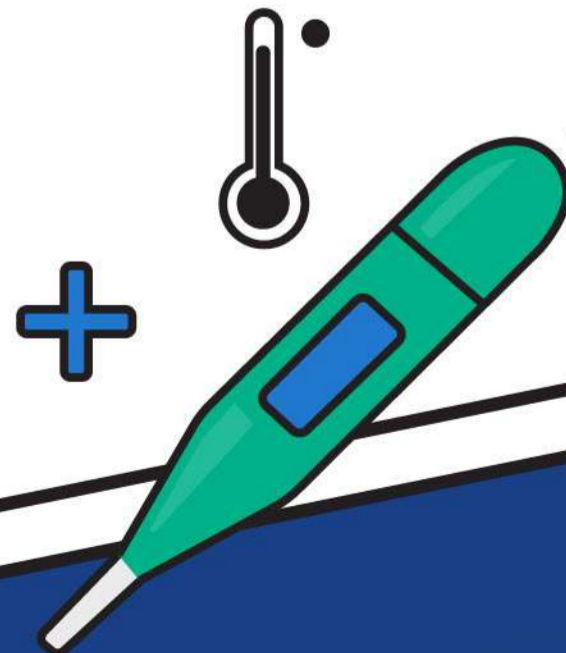

TABLE OF CONTENT

Section 1: BRAND INTRODUCTION

1.1 Brand Story	01 - 03
1.2 Brand Model	04

Section 2: BRAND IDENTITY

2.1 Logos	05 - 13
2.2 Color Palette	14 - 15
2.3 Typography	16
2.4 Tone of voice	17
2.6 Social	18
2.7 Photography	19 - 20

BRAND INTRODUCTION

Brand Story

Value is at the heart of what we do. We believe healthcare should be easy, affordable, and accessible to all. That's why we built myAster.

At myAster, our mission is to make healthcare easy, affordable, and accessible to everyone. We believe that when you have access to the right information and services, you can take control of your health and your life.

myAster is a digital platform that makes it easy to connect with doctors, book appointments, and order medicines from the comfort of your home.

We strive to deliver value and make it easy for you to connect with doctors, book appointments, and order medicines. With myAster, you'll get a personalized experience that makes the most of your time with us.

#MyHealthInMyHands

Brand Model



BRAND IDENTITY

Logo

Primary Logo

The position and proportions of the logo are strictly fixed. They must not be changed or redrawn for any reason.

Secondary Logo

The logo can be used with Wordmark at the top and tagline at the bottom.



Logo exculsion zone

The exclusion zone is essential for the logo to be clearly distinguishable from other graphic elements. Therefore, please avoid positioning any elements closer than the defined zone.



Minimum size

Here are the minimum logo sizes.
Please avoid reducing it further.
The logo will be illegible.

myAster
My Health In My Hands

Minimum size: 45px, 5cm



**my
Aster**

My Health In My Hands

Minimum size: 60px, 2cm



Composite logo/ Co-branding lockup

Configurations

Co-branding lockup is in horizontal and vertical configurations.

Choose the configuration that best fits your needs.

Note: The myAster brand in the first position is preferred, but partner agreements and contracts may dictate otherwise.

Configurations



Horizontal



Vertical

Color variation

Reverse logos are super useful for making your logo stand out when placed on top of good quality color photographs on flyers, posters or brochures for example, without any unpleasant color clashes with the background imagery.

White

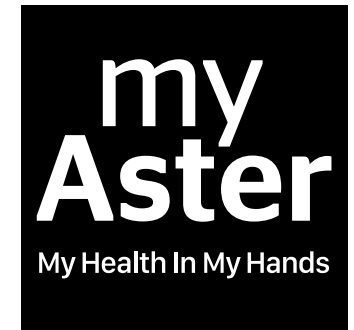

Monochromatic



Digital Logo Usage

App icon

The position and proportions of the logo are strictly fixed. They must not be changed or redrawn for any reason.

Website icon

The logo can be used with Wordmark at the top and tagline at the bottom.

App Icon



196 X 196 px
Chrome for Android
home screen icon



192 X 192 px
Google developer web app
manifest recommendation



32 X 32px
Favicon: Standard for
most desktop browser

Website Icon



Don't usage

To preserve the integrity of the logo, please avoid executions that misuse, amend, or trivialize the identity. Here are some examples of what not to do.



Do not deform the logo



Do not change the distance



Do not apply drop shadow



Do not change the proportions



Do not skew, stretch or bend



Do not apply on complex background

Use of logo on complex backgrounds

You can use the logo with a white background. This will avoid the logo "getting lost" on a very complex background and create a pleasing contrast effect.



Use in text

In Marketing or Internal communication, it must always be used as **“myAster”**

⊘ not “my Aster”, “MyAster” or “MYASTER”.

Color Palette

Primary Colors

The logo is mainly made using these three colors and the brand can be expressed using these colors.



R 19 / G 170 / B 112
C 77 / M 0 / Y 70 / K 0
#13AA70



R 35 / G 87 / B 164
C 91 / M 66 / Y 0 / K 0
#2357A4

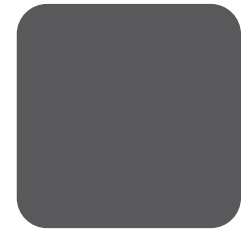

R 89 / G 90 / B 92
C 60 / M 50 / Y 46 / K 39
#595A5C

Secondary Colors

The logo can be used with Wordmark at the top and tagline at the bottom.



R 117 / G 167 / B 202
C 58 / M 24 / Y 11 / K 1
#75a7ca



R 243 / G 241 / B 241
C 6 / M 5 / Y 5 / K 0
#f3f1f1

Color Palette

Tertiary Colors



R 76 / G 175 / B 80
C 77 / M 0 / Y 93 / K 0
#4CAF50



R 33 / G 150 / B 243
C 78 / M 32 / Y 0 / K 0
#2196F3



R 103 / G 58 / B 183
C 77 / M 81 / Y 0 / K 0
#673AB7



R 156 / G 39 / B 176
C 56 / M 86 / Y 0 / K 0
#9C27B0



R 0 / G 150 / B 136
C 81 / M 17 / Y 53 / K 2
#009688



R 244 / G 67 / B 54
C 0 / M 84 / Y 76 / K 0
#F44336

Neutrals Colors



R 204 / G 204 / B 204
C 23 / M 17 / Y 18 / K 1
#CCCCCC



R 77 / G 77 / B 77
C 62 / M 52 / Y 50 / K 48
#4D4D4D



R 37 / G 37 / B 37
C 73 / M 64 / Y 59 / K 76
#252525

Our font

Font family:

Titillium Web

This font is flexible and It is an open type font and is available for both Mac and PC. It is the first choice for print, web and on-screen displays. It has a variety of weights and scale, and is highly visible.

Titillium Web

ABCDEFGHIJKLMNO
PQRSTUVWXYZÀÁÊ
abcdefghijklmnpqr
stuvwxyzàáêîõøü&1
234567890(\$£€.,!?)

Titillium Styles

Thin

Thin Italic

Light

Light Italic

Regular

Regular Italic

Semibold

Semibold Italic

Bold

Bold Italic

Black

Tone of voice

- Caring
- Warm
- Human Inclusive
- Friendly
- Informative
- Positive & energetic

We look at the bright side of life and try to have friendly conversations with our users. We converse with enthusiasm and a cheerful and warm tone.

We have a lot to tell our users! We speak in a clear, straightforward, and concise manner, which helps our customers make informed decisions.

We genuinely care about our customers and express that we always have their best interests at heart. Therefore, our tone is warm, sincere and helpful.

Our users are diverse, and they come to us for information; we ensure that our communication is straightforward and relateable to make informed decisions. As a result, we are always timely and transparent.

Social

Placement of logo as shown



Photography Do's

Photography should be Warm, Happy, positive, and Human inclusive



Photography Dont's

Photography should not display emergencies, rush, panic, and graphically disturbing



Thank You

Medcare Brand Guidelines

How did the brand become so successful?

They did everything by the book.

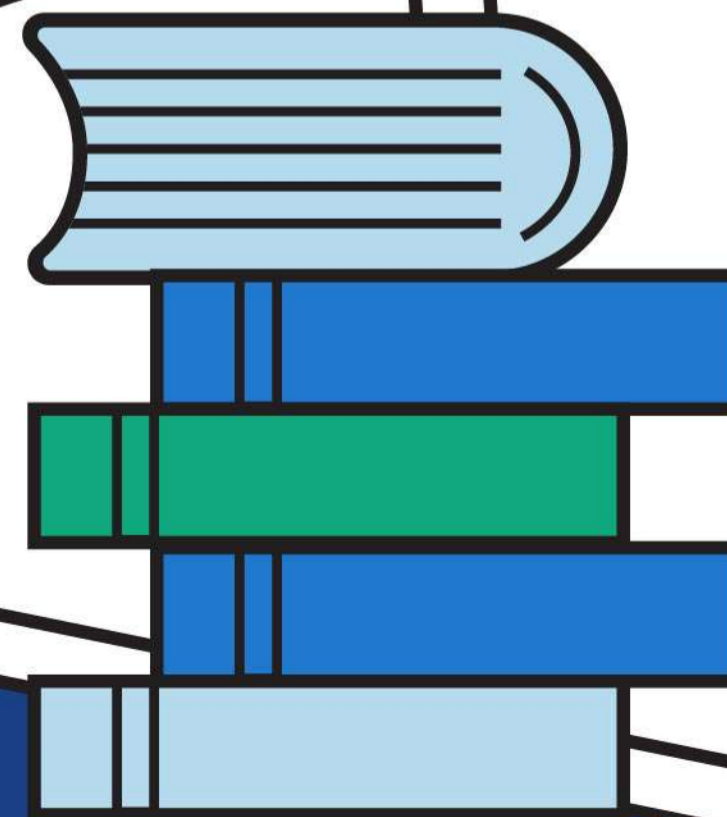



HOSPITALS
& MEDICAL CENTRES
WE'LL TREAT YOU WELL

Brand Guidelines





01

Introduction

On the following pages, you will find an explanation of the characteristics of the Medcare brand and detailed instruction on how to reproduce and apply the visual identity system. As consistency in our visual presentation is one of the keys to the success of our brand, please follow these guidelines closely to ensure the consistent treatment of the visual identity system across all of our communications.



WE ARE **MEDCARE**

The Medcare brand tells the story of who we are and what our promise is to the people we work with and the communities we serve. We are more than just a group of experts, each working in our respective fields— we are an organization working together toward a greater purpose.

In today's world, healthcare is often delivered as a series of disjointed and impersonal experiences. At Medcare, we stand for something more. Our purpose is to build connections and partner with patients at every point in their healthcare experience. We are innovative, collaborative, and compassionate. Our system is dedicated to providing a coordinated continuum of high quality care, creating lifelong relationships with patients, and bringing the future of healthcare to everyone we touch.

It is our promise to everyone who interacts with our system, and we will bring it to life in every aspect of our business.



BRAND **PROMISE**

Brand promise is what an organization commits to the people who interact with it. It's not a description of what a company does in a literal sense. It's a description of the company's character. To some extent, it's a mission; it's how the organization creates and delivers value. Also, it's the feeling that the organization conveys to its stakeholders.

The brand promise is an extension of a company's positioning, though it's not necessarily the same thing. If you think of positioning as the fertile ground that allows a brand to germinate, grow and thrive, the brand promise is the brand's fruit—it's the expected tangible benefit that creates desire for a product or service. To sustain that desire, however, the harvest must be appealing and bountiful year after year.



WE'LL TREAT YOU WELL

Brand promise is what an organization commits to the people who interact with it. It's not a description of what a company does in a literal sense. It's a description of the company's character. To some extent, it's a mission; it's how the organization creates and delivers value. Also, it's the feeling that the organization conveys to its stakeholders.

The brand promise is an extension of a company's positioning, though it's not necessarily the same thing. If you think of positioning as the fertile ground that allows a brand to germinate, grow and thrive, the brand promise is the brand's fruit—it's the expected tangible benefit that creates desire for a product or service. To sustain that desire, however, the harvest must be appealing and bountiful year after year.



MED
CARE

THE 3 E'S OF MEDCARE

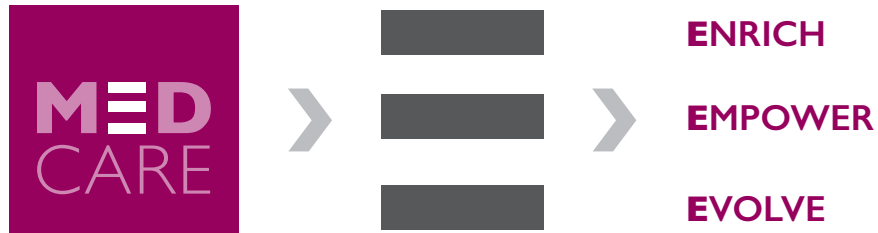

ENRICH

At Medcare, we believe in enriching the experience of all those who come in touch with our brand and our services – right from internal stakeholders to our customers and business partners. From careers to customer experience – we strive to add value to every aspect of our business. We believe that healthcare is not just a service but also an experience that should enrich people at difference levels.

EMPOWER

At Medcare, we believe in continuously empowering all our stakeholders. Through regular educational programs that empower our team members with the latest advancement in the medical world; to continuous community outreach efforts to take the message of good health everywhere, we strive to bring about a positive change in the way healthcare is delivered.

EVOLVE

At Medcare, we believe that success comes to those who continuously evolve. We believe in staying abreast with best practices in the healthcare business that allows us to stay ahead of times and deliver promising solutions to our customers. We believe in moving forward as a team by continuously attracting the best talent and therefore evolving as a successful, sustainable business.



MEDCARE

VISION, MISSION & VALUES

VISION

A caring mission with a global vision

MISSION

To develop a leading healthcare system that promotes and supports the highest standards in preventive, curative and rehabilitative healthcare, regionally and internationally.

VALUES

Integrity: Doing the right thing without any compromises and embracing a higher standard of conduct

Passion: Going the extra mile willingly, with a complete sense of belongingness and purpose while adding value to our stakeholders

Respect: Treating people with utmost dignity, valuing their contributions and fostering a culture that allow each individual to rise to their fullest potential

Excellence: Surpassing current benchmarks constantly by continually challenging our ability and skills to take the organization to greater heights

Compassion: Going beyond boundaries with empathy and care

Unity: Harnessing the power of synergy and engaging people for exponential performance and results



BRAND PERSONALITY

Brand personality is the way a brand speaks and behaves. It means assigning human personality traits/characteristics to a brand so as to achieve differentiation. These characteristics signify brand behavior through both individuals representing the brand (i.e. it's employees) as well as through advertising / marketing communication. When brand image or brand identity is expressed in terms of human traits, it is called brand personality. Brand personality develops brand equity. It sets the brand attitude. It is a key input into the look and feel of any communication or marketing activity by the brand.

Medcare Hospitals & Medical Centres Writing Style

Medcare Hospitals & Medical Centres Writing Style

When referring to the hospital, writers must use "Medcare Hospitals & Medical Centres" on first reference and "Medcare" on all subsequent references.

The use of the acronym MCH, MHS, MMC, MWCH and MOSH is not permitted.

English United Kingdom is the approved language spelling.

Medcare Hospitals & Medical Centres adheres to AP style in all our official communications.

- **Spell out:** Whole numbers below 10, numerals that start a sentence, in large numbers use hyphen to connect words ending in y to another word in large numbers.
- **Use figures:** For 10 and above, and for all ages and percentages (even less than 10).
- **Days vs dates:** Always use numerals without st, nd, rd or th in dates, avoid using yesterday, today and tomorrow, when writing about events use months and dates (April 30 and June 5), when referring to a month, day and year; set off year with commas (Aug. 1995, 20, was the date of the symposium).
- **Titles:** Capitalize all words four letters or longer; do not capitalize articles "a," "an" and "the" OR conjunctions or prepositions, unless four letters or longer; do not capitalize "the" in title.
- **Colon:** Capitalize first word after colon only if it is a proper noun or start of a complete sentence (He promised this: The company will make good revenues this year. But: There were three considerations: expense, time and feasibility).
- **Hyphen:** Use a hyphen for compound adjectives before the noun (well-known doctor, full-time job), do not use when compound modifier occurs after verb (The doctor was well known. Her job became full time).
- **Period:** Use a single space after period at end of sentence, do not put space between initials.
- **Quotations in the news:** Quote marks indicate exact wording, quote marks always appear outside punctuation, use single marks for quotes within quotes (She said, "He told me, 'I need a blood test.'").



PERSONALITY THAT BECOMES PERSONAL

The Medicare brand believes on connecting with the customer on an emotional level. The brand experience becomes more enriching when it becomes personal and personalized. The Medicare brand thrives on the following personality traits:

CARING. We believe that it is caring that plays a major part in curing. It is not just about procedures and prescriptions. It is the atmosphere and experience that help people recover faster and better. This aspect of being cared for should become the primary trait of the brand.

SHARING. When you care, you learn to share. Medicare believes in sharing knowledge. It is not just about bringing people to the physician that Medicare believes in. It is about helping people live lives better. When this trait is exercised in communication and interaction, the perception of the brand will also evolve into a more personal experience.

POSITIVE. When caring and sharing happens there is a spread of positivity across all platforms. It has been widely accepted that positivity is one of the best forms of cure. Positivity in action and communication is one of our strongest traits, which when exercised brings life to the brand and its perception.

PROGRESSIVE. The outcome of all the above personality traits is the desire to always keep going further, in terms of technology, innovations and solutions. This personality trait drives the brand towards much required change and evolution.



BRAND LANGUAGE

Creating a unified 'tone of voice' across all channels of communication that speaks your target audience's language is a way of making you heard above the market chatter. A picture says a thousand words but for brands trying to reach out to new and existing customers, verbal and written language is becoming as important as visual identity in marketing communications. Our brand language expresses the unique character of our brand and brings a consistent style to all of our written communications.

One Language. Our Language.

By the nature of what we do, we often communicate about difficult, and sometimes painful, subjects. With this in mind, it may help to ask:

- Do your words communicate genuine understanding?
- Do they invoke a feeling of being cared for?
- Do they invoke a feeling of progressive thoughts?
- Do they empower and inform the reader or listener?

Similarly, due to the complex subjects we deal with, the words we use need to be as simple and accessible as possible. This means they need to be:

- Free of jargon;
- Free of acronyms; and
- Free of overly technical language.



02

Brand Identity

02

Brand Identity

I. LOGO CONSTRUCTION

Logo Construction



02

Brand Identity

2. LOGOSET

Medcare Hospitals & Medical Centres Logo

Medcare logo with tag line

Our tagline “**We’ll Treat You Well**” is a mission statement and a promise. It speaks to our tireless commitment to improving the lives of all our patients and their families through top-quality health care.

The tagline must be used on covers of print pieces, on posters, on Web home pages and in other prominent positions in a variety of communications. The tagline must also be used with the logo for external placements that would benefit from the additional context it provides.



Black Background



White Background

02

Brand Identity

4. CLEAR SPACE

The Medicare Hospitals & Medical Centers logo is the primary visual identifier of our brand. It comprised of the Medicare logotype and tagline when applicable.

When it is necessary to use the logo without the tagline, be sure that the tagline is featured prominently elsewhere on the piece.

The minimum size of the logo was designed specifically for usage at very small sizes and should be used only at the sizes specified.

Do not change the logo's original artwork. Do not rebuild or distort the logo. Do not change the logo colors. Do not insert the logo into text.

Clear Space for Logo



Logo Minimum Size

For use across any media, and to maintain proper visibility, it is advised that the logo should not be used at a size less than 1 cm height.



02

Brand Identity

5. DO'S & DON'TS



02

Brand Identity

6. LOGO PLACEMENT ON IMAGE

Placement of logo on images

For better visibility of logo on images/other background colors (other than black & white), a black transparent gradient is used behind logo.

RICH BLACK

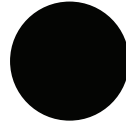

PANTONE BLACK

R : 0 C : 75 %
G : 0 M : 68 %
B : 0 Y : 67 %
 K : 90 %

Hex Code
#RRGGBB #000000



Gradient slider

Black (opacity=0)

Transparency : Multiply/Normal



02

Brand Identity

7. LOGO MISUSE

To avoid inconsistent reproduction, the logo has been carefully designed and should never be altered in any way. These examples illustrate how NOT to use the logo.

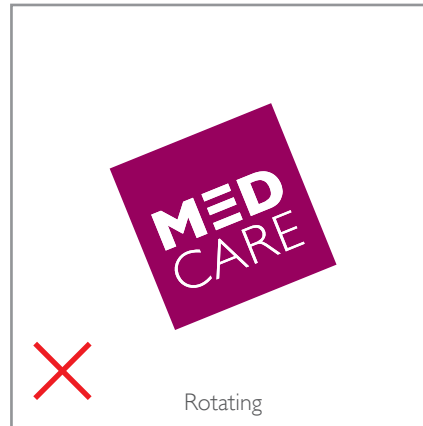

logotype is only allowed to place on approved background colours i.e. white, black & black transparent gradient.

02

Brand Identity

8.
Dos and do nots
on image usage:

Do

Use close cropping to focus on people in order to increase dramatic effect or isolate emotion.
Use good lighting with attention to depth and shadow.

Be warm, playful and engaging (when appropriate).

Have a fresh, unique and unexpected viewpoint.
Reflect the diversity of our patients and employees.

Show subjects following all proper safety and regulatory procedures.

Use images that are technically sound, properly color-balanced and reproduced at the correct resolution.

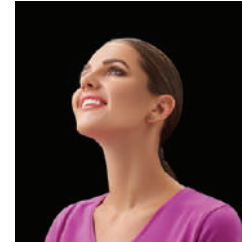

Do not

Show subjects in pain or distress unless there is an editorial reason for doing so.

Use photos that are harshly lit, especially from artificial overhead lighting.

Be overly dramatic or show subjects in contrived or unrealistic situations.

Distort proportions. When resizing, make sure that the height and width are scaled in equal measure.

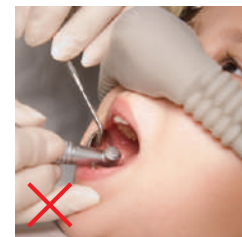

02

Brand Identity

9. COLOUR PALETTE



LILAC

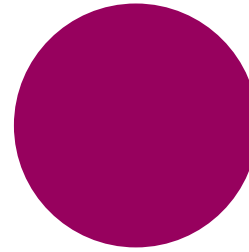

PANTONE : 235C

R : 151 C : 5 %
G : 0 M : 100 %
B : 94 Y : 0 %
 K : 40 %

Hex Code
#RRGGBB # 97005E

RICH BLACK

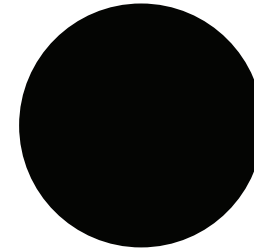

PANTONE BLACK

R : 0 C : 75 %
G : 0 M : 68 %
B : 0 Y : 67 %
 K : 90 %

Hex Code
#RRGGBB # 000000

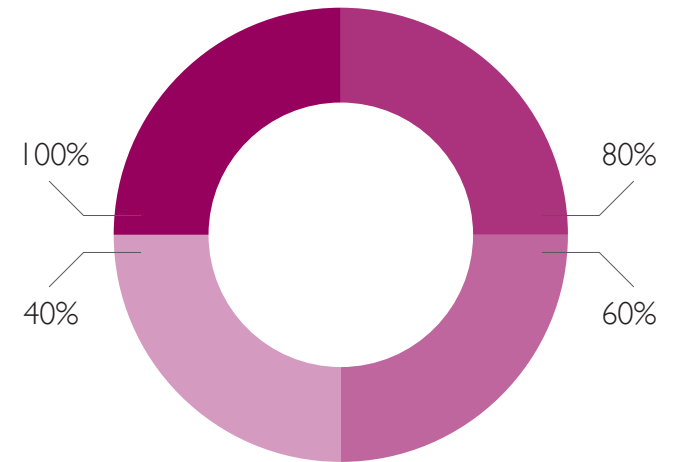

Opacity Variants

02

Brand Identity

10. LOGO FORMAT

LOGO FILE FORMATS

Choosing the right logo file Image formats are usually separated into two groups: vector-based images and bitmap images. As a rule of thumb, vector images are preferred in print jobs (magazines, brochures), and JPG or PNG images are preferred in the digital world (Microsoft Office and Web applications).

The biggest difference between the two image groups is that only the vector-based images can be scaled to any size without deteriorating the quality of an image. Enlarging a JPG or PNG will make its pixels visible, which will cause the image to lose its focus and become blurry. It is because of this lack of scalability that there are no logo originals available in bitmap formats. Every time a bitmap logo is needed, it should be created on a case-by-case basis from a vector image scaled to the required size.

The Medicare Hospitals & Medical Centres and the verticals logos are available in EPS (vector) file format.



Vector
can be scaled to any size



Pixel
limited scaling

The Medicare logo files are available in:

- CMYK colors (four color)
- PANTONE colors

Four-color printed material:

Publications
Advertisements Brochures

Logo EPS format

Two-color printed material:

Business cards
Printed stationery
Shipping boxes, labels, etc.

Logo EPS format

Black-and-white printed material:

Publications Advertisements

Logo EPS format

Microsoft Office documents:

Microsoft Word
Microsoft PowerPoint

Logo JPG format
PNG format

Internet applications:

Web programs
Flash animations

Logo JPG format
PNG format

02

Brand Identity

11. TYPOGRAPHY English

The consistent use of type contributes to our unique look and feel, making us easily distinguishable from other institutions.

The designated brand typefaces are **Gill Sans** and **Gill Sans MT Pro**. They have a modern and crisp clarity, with an approachable feel. As a sturdy, low contrast, geometric and highly legible typeface, they are very well-suited for display and text use.

Gill Sans is used for headlines and in other situations where you want larger type to stand out from the standard brand typeface.

PRIMARY TYPEFACE English

Gill Sans / Gill Sans MT Pro

Gill Sans is the primary font used in the logo & Artworks

- GILL SANS light
- GILL SANS Regular**
- GILL SANS Semibold**
- GILL SANS Bold**
- GILL SANS MT PRO Book
- GILL SANS MT PRO Medium

Aa

ABCDEFGHIJKLMNOPQRSTUVWXYZ
abcdefghijklmnopqrstuvwxyz (.,:;!£\$&@*)
0123456789

ABCDEFGHIJKLMNOPQRSTUVWXYZ
abcdefghijklmnopqrstuvwxyz (.,:;!£\$&@*)
0123456789

ABCDEFGHIJKLMNOPQRSTUVWXYZ
abcdefghijklmnopqrstuvwxyz (.,:;!£\$&@*)
0123456789



text color

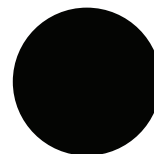

R : 0 C : 75 %
G : 0 M : 68 %
B : 0 Y : 67 %
 K : 90 %

Hex Code
#RRGGBB # 000000



R : 65 C : 0 %
G : 64 M : 0 %
B : 66 Y : 0 %
 K : 90 %

Hex Code
#RRGGBB # 414042

02

Brand Identity

12. TYPOGRAPHY English

Medicare Hospitals &
Medical Centres
Web-safe typeface

While consistency is important, there are some limitations when using typefaces online. When Gill Sans cannot be used in digital applications or on the Web, Arial should be used as an alternative.

WEB-SAFE TYPEFACE ENGLISH

Aa

Arial

Arial Regular
Arial Bold

ABCDEFGHIJKLMNOPQRSTUVWXYZ
abcdefghijklmnopqrstuvwxyz (.,:;!£\$&@*)
0123456789

ABCDEFGHIJKLMNOPQRSTUVWXYZ
abcdefghijklmnopqrstuvwxyz (.,:;!£\$&@*)
0123456789



text color

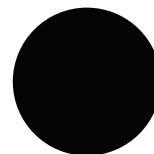

R : 0 C : 75 %
G : 0 M : 68 %
B : 0 Y : 67 %
 K : 90 %

Hex Code
#RRGGBB # 000000



R : 65 C : 0 %
G : 64 M : 0 %
B : 66 Y : 0 %
 K : 90 %

Hex Code
#RRGGBB # 414042

02

Brand Identity

13. TYPOGRAPHY Arabic

PRIMARY TYPEFACE

Arabic

GE S S T W O

Light

Medium

Bold



text color

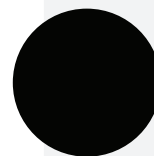

R : 0 C : 75 %
G : 0 M : 68 %
B : 0 Y : 67 %
K : 90 %

Hex Code
#RRGGBB # 000000

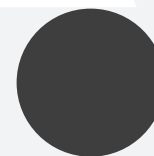

R : 65 C : 0 %
G : 64 M : 0 %
B : 66 Y : 0 %
K : 90 %

Hex Code
#RRGGBB # 414042



ءآؤ | ئ | ا | ب | ت | ث | ج | ح | خ | د | ذ | ر | ز | س | ش | ص
ض | ط | ظ | ع | غ | ف | ق | ك | ل | م | ن | ه | و | ي |
١٢٣٤٥٦٧٨٩٠

ءآؤ | ئ | ا | ب | ت | ث | ج | ح | خ | د | ذ | ر | ز | س | ش | ص
ض | ط | ظ | ع | غ | ف | ق | ك | ل | م | ن | ه | و | ي |
١٢٣٤٥٦٧٨٩٠

ءآؤ | ئ | ا | ب | ت | ث | ج | ح | خ | د | ذ | ر | ز | س | ش | ص
ض | ط | ظ | ع | غ | ف | ق | ك | ل | م | ن | ه | و | ي |
١٢٣٤٥٦٧٨٩٠

02

Brand Identity

14. TYPOGRAPHY Style



Headline in Gill Sans Semi Bold

Sub Head in Gill Sans Semibold

Lorem ipsum dolor sit amet, consectetur adipiscing elit, sed diam nonummy nibh euismod tincidunt ut laoreet dolore magna aliquam erat volutpat. Ut wisi enim ad minim veniam, quis nostrud exerci tation ullamcorper suscipit lobortis nisl ut aliquip ex ea commodo consequat. Duis autem vel eum iriure dolor in hendrerit in vulputate velit esse molestie consequat, vel illum dolore eu feugiat nulla facilisis at vero eros et accumsan et iusto odio dignissim qui blandit praesent luptatum zzril delenit augue dui

- Lorem ipsum dolor sit amet, consectetur adipiscing elit, sed diam nonummy nibh euismod tincidunt ut laoreet dolore magna aliquam erat volutpat. Ut wisi enim ad minim veniam, quis nostrud exerci tation ullamcorper suscipit lobortis nisl ut aliquip ex ea commodo consequat. Duis autem vel eum iriure dolor in hendrerit in vulputate velit esse molestie consequat praesent luptatum zzril delenit.

6mm Tab Space

Lorem ipsum dolor sit amet, consectetur adipiscing elit, sed diam nonummy nibh euismod tincidunt ut laoreet dolore magna aliquam erat volutpat. Ut wisi enim ad minim veniam, quis nostrud exerci tation ullamcorper suscipit



font size : 15pt - 20 pt
color : Medicare Lilac

Headline in Gill Sans Semi Bold

font size : 12pt - 14 pt

Sub Head in Gill Sans Semibold

Lorem ipsum dolor sit amet, consectetur adipiscing elit, sed diam nonummy nibh euismod tincidunt ut laoreet dolore magna aliquam erat volutpat. Ut wisi enim ad minim veniam, quis nostrud exerci tation ullamcorper suscipit lobortis nisl ut aliquip ex ea commodo consequat. Duis autem vel eum iriure dolor in hendrerit in vulputate velit esse molestie consequat, vel illum dolore eu feugiat nulla facilisis at vero eros et accumsan et iusto odio dignissim qui blandit praesent luptatum zzril delenit augue dui

- Lorem ipsum dolor sit amet, consectetur adipiscing elit, sed diam nonummy nibh euismod tincidunt ut laoreet dolore magna aliquam erat volutpat. Ut wisi enim ad minim veniam, quis nostrud exerci tation ullamcorper suscipit lobortis nisl ut aliquip ex ea commodo consequat. Duis autem vel eum iriure dolor in hendrerit in vulputate velit esse molestie consequat praesent luptatum zzril delenit.

6mm Tab Space

Paragraph
in Gill Sans Light font

Font size specifications

Headline : 15 - 20

Sub Head : 12 - 14

Paragraph : not less than 8

Spacing specifications

Tab space between bullet : 6mm

Space Between Subhead & Head : 3 step

Space Between head & paragraph : 1 step

one step space

Shift + arrow (Adobe)

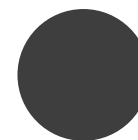

R : 65 C : 0 %
G : 64 M : 0 %
B : 66 Y : 0 %
 K : 90 %

Hex Code
#RRGGBB # 414042



03

Photography

03

Photography

I. PHOTOGRAPHY STYLE

Overall, Medcare Hospitals & Medical Centres' photography style is genuine, unexpected and sensitive. Our photographs should never feel staged or artificial. Subjects should look natural, never posed — as though captured in a real moment.

Patients, children and families' images should be spontaneous and carefree; they should capture the joy of quality life whenever possible and support the tagline ideal "We'll Treat You Well!". Outdoor activities and bright natural lighting are preferred.

Hospital staff and employees' photographs should be active and shot in real-life situations as appropriate. Commercial stock images should not be used to represent Medcare staff and employees.





04

Corporate Designs

04

Corporate Designs

I. SOCIAL MEDIA Option 1

Logo placement in gradient black bg

Image

Band 1

Band 2

MED CARE HOSPITALS & MEDICAL CENTRES
WE'LL TREAT YOU WELL

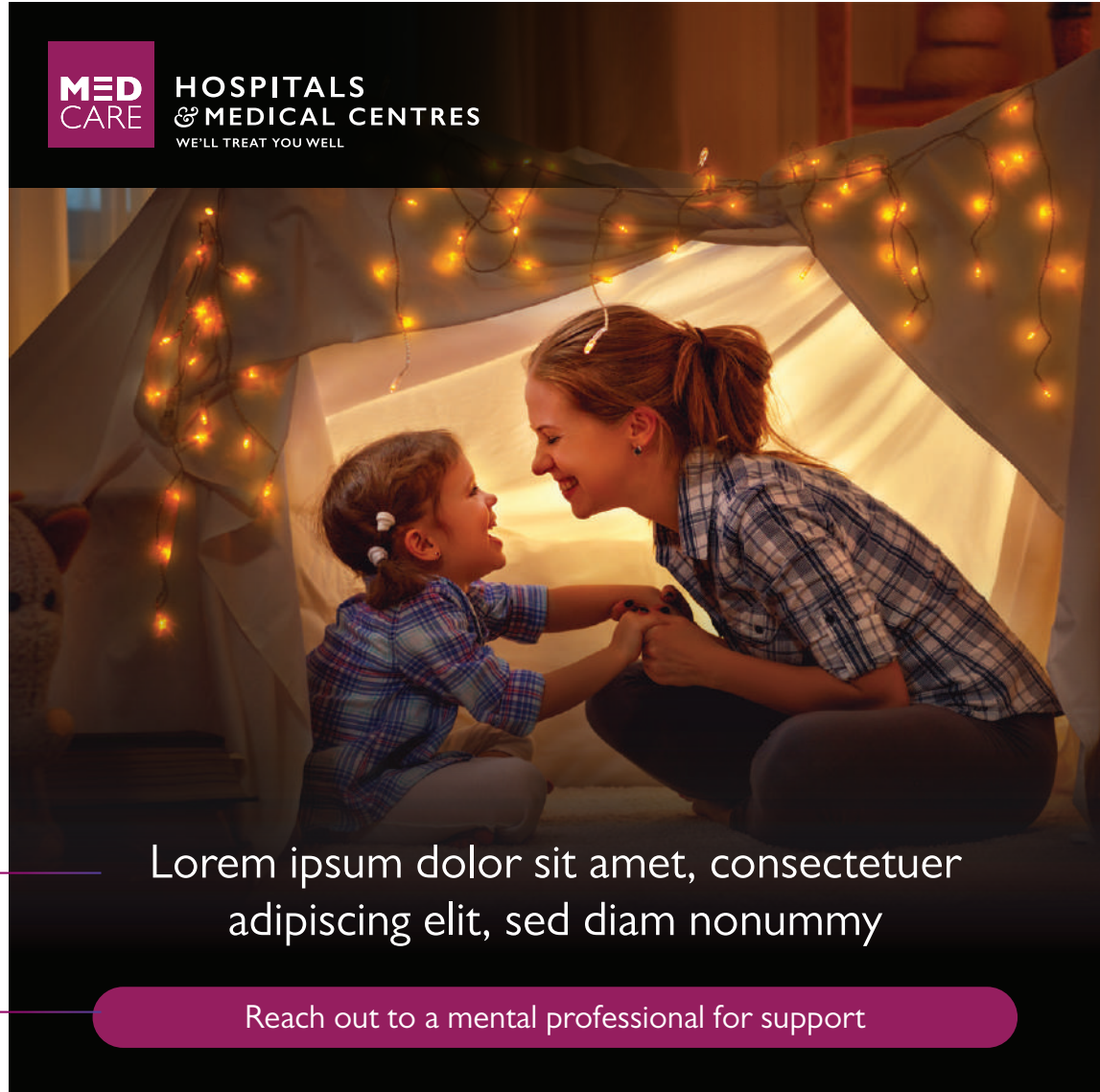

Band 1
Lorem ipsum dolor sit amet, consectetur adipiscing elit, sed diam nonummy

Band 2
Reach out to a mental professional for support

Title & Contents

SIZE : 1200 x1200 pixel
RGB 72dpi

Font Size :
Band 1 48 pt
Band 2 33 pt

04

Corporate Designs

2. WEBSITE BANNER

Text

Image

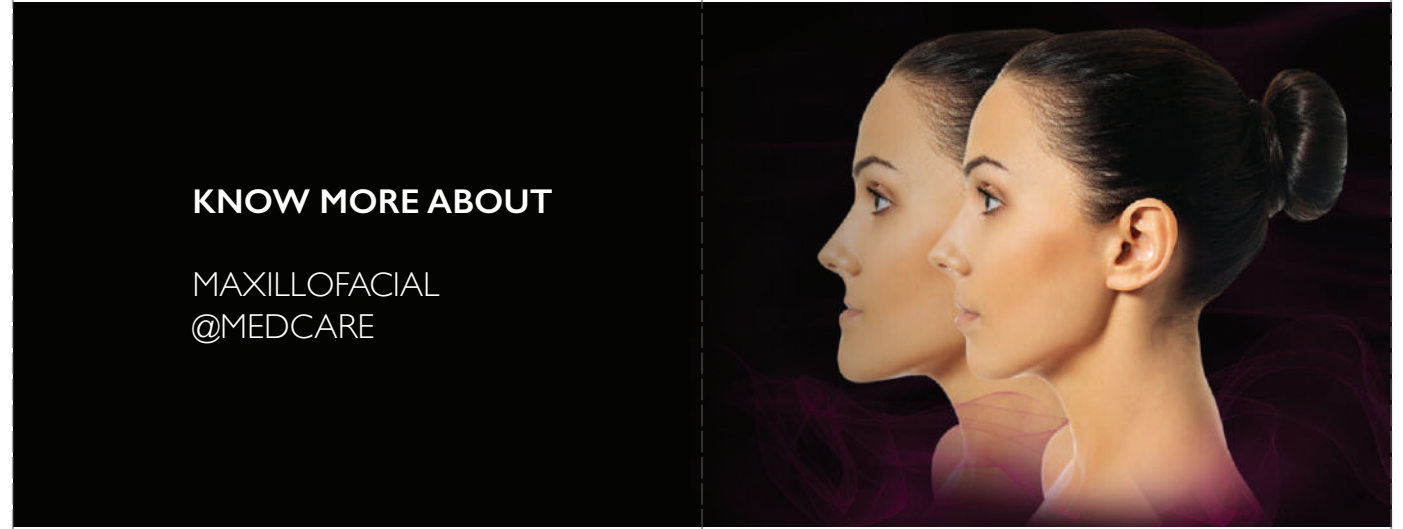

SIZE : 8200 x3120 pixel
RGB 72dpi

04

Corporate Designs

3. FLYER



1

Logo placement in black bg

2

Image

3

Title & Contents in lilac bg

SIZE : DL Flyer (9.9 × 21 cm)
paper thickness : 250 gsm
Finishing : Matte

Design Structure

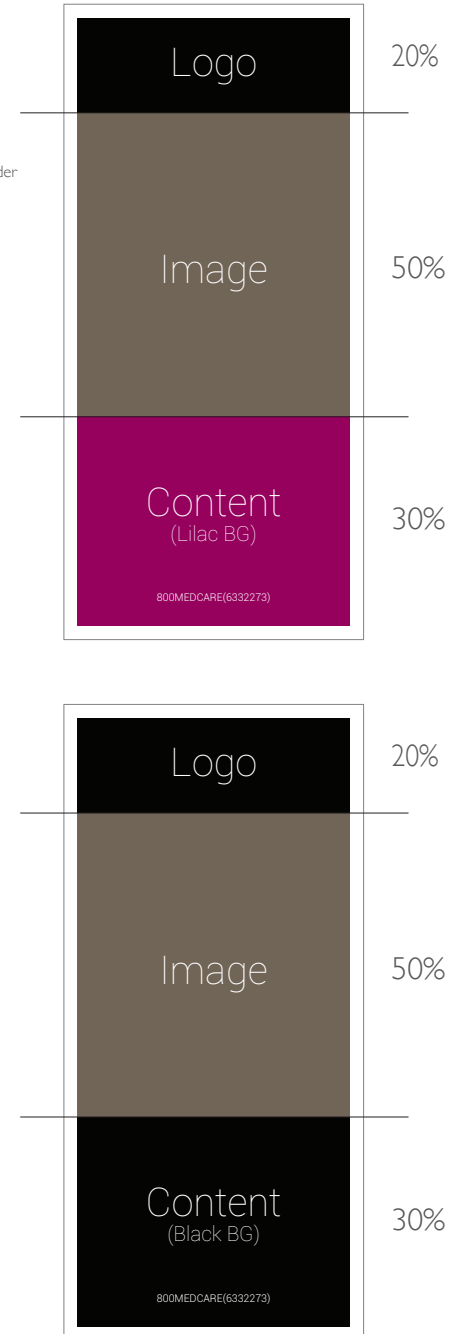

Division ratio : 20:50:30

04

Corporate Designs

4. POSTER

Design Structure



Image section should be higher than content section

SIZE : A3, A2
paper thickness : 300 gsm
Finishing : Matte



04

Corporate Designs

5. ROLLUP

1

Logo placement in black bg

2

Image

3

Title & Contents

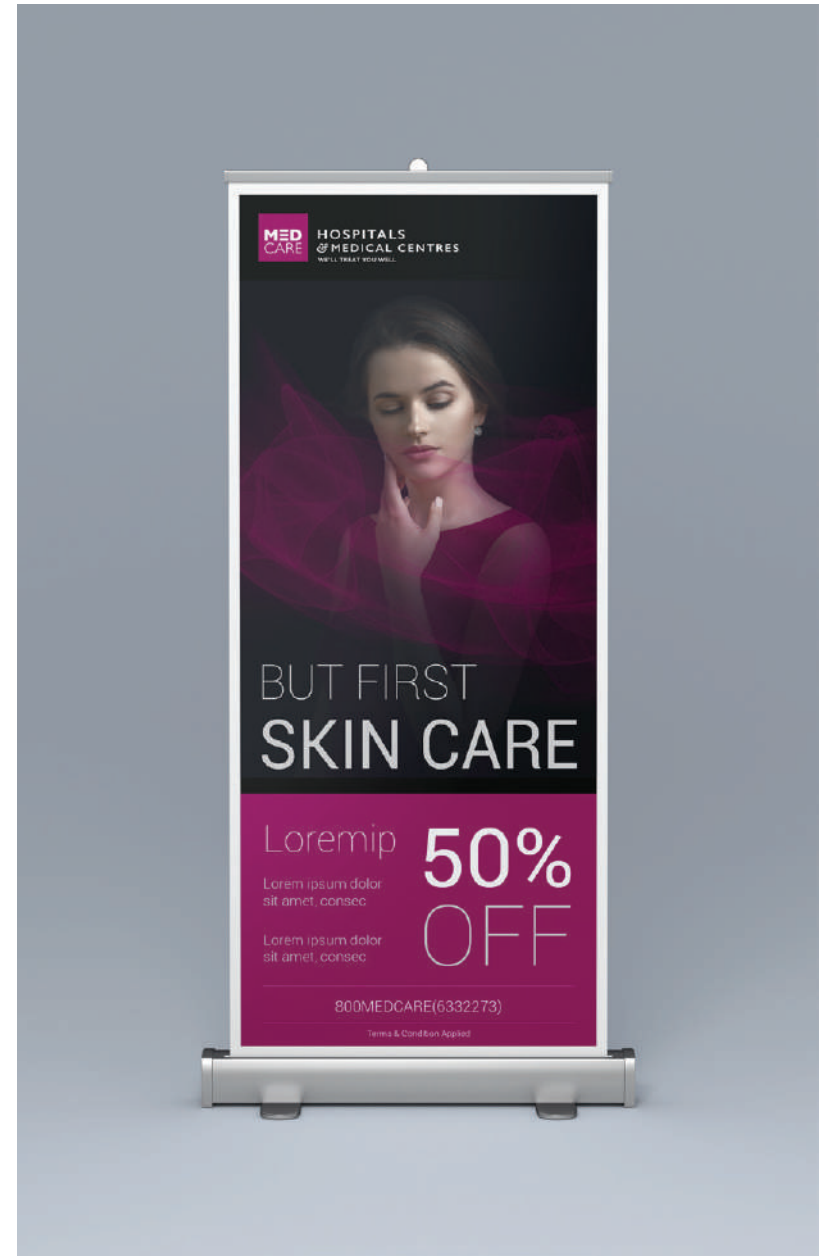
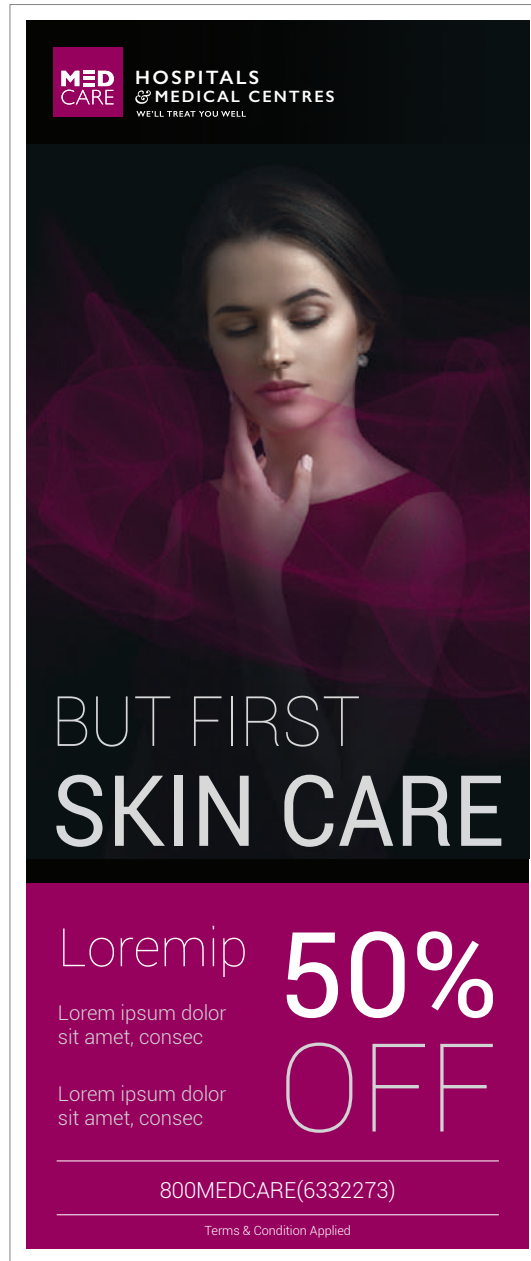

Image section should be higher than content section

Size : 85x200cm

04

Corporate Designs

6. PAPER BAG

Medcare Hospitals & Medical Centres' stationery is based on templates in which the logo size and position are fixed, margins are established, and type is set in the Gill Sans typeface. This gives a consistent appearance to our communications across all departments and assures the recipients that what they are receiving is authentic.

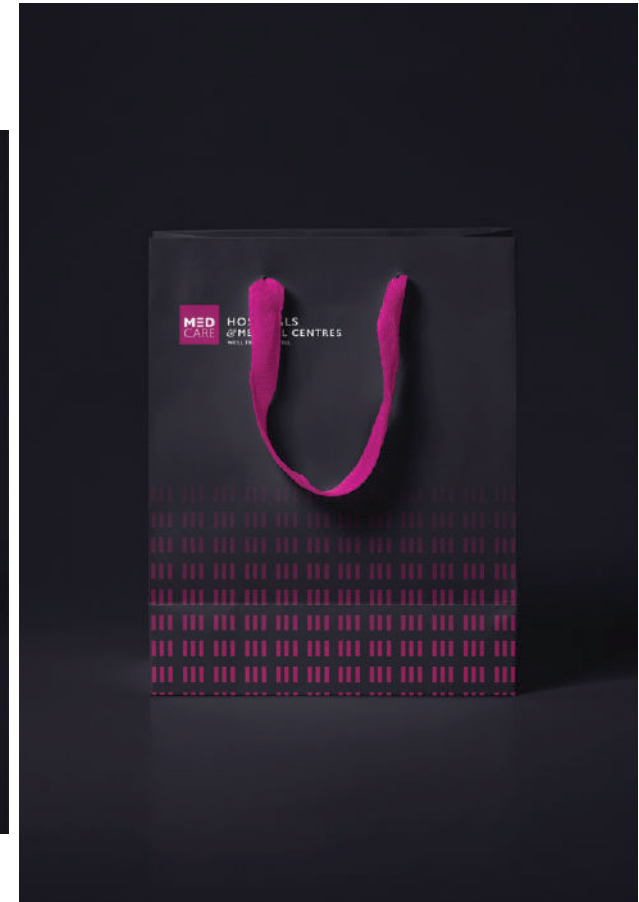

Size : A4
Paper thickness : 350gsm
finishing : matte

04

Corporate Designs

7. LETTER

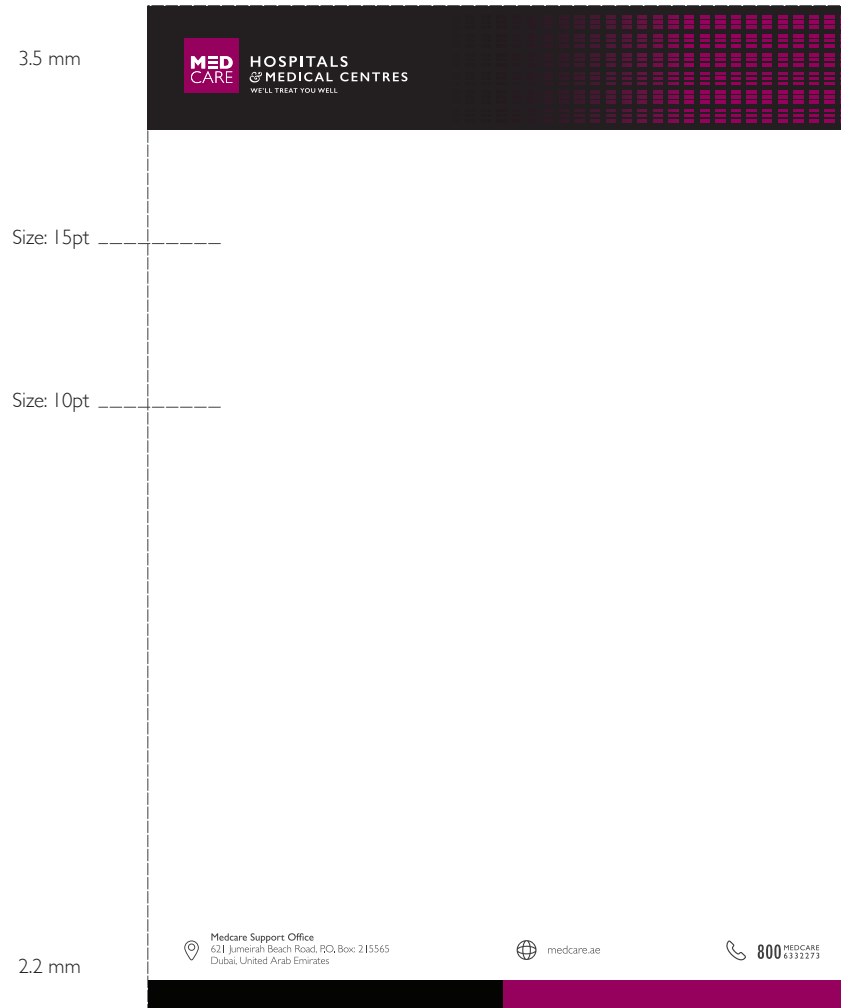

Size : A4

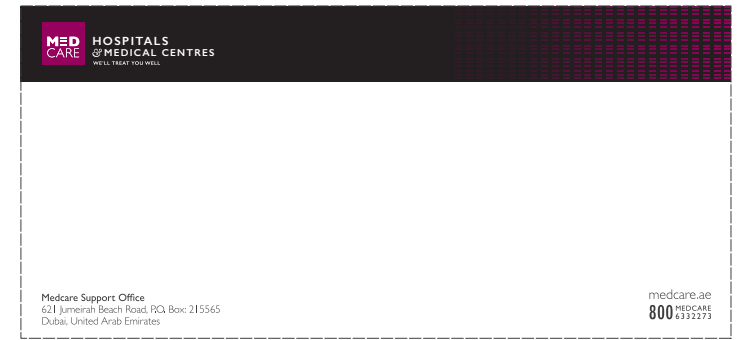

Size : 22 x 11.5
Paper thickness : 100gsm



Size : 9 x 5.5 cm
corner radius : 4mm
Paper thickness : 300gsm
finishing : matte



The stationery should be ordered through the Marketing and Communications (Marcom) department by placing a printing request at xxxx
The layout has been designed to accommodate varying quantities and types of information. The Marcom team will work with you to find an appropriate arrangement for personalized information, but deviation from the established stationery templates is not permitted.

04

Corporate Designs

8. FOLDER

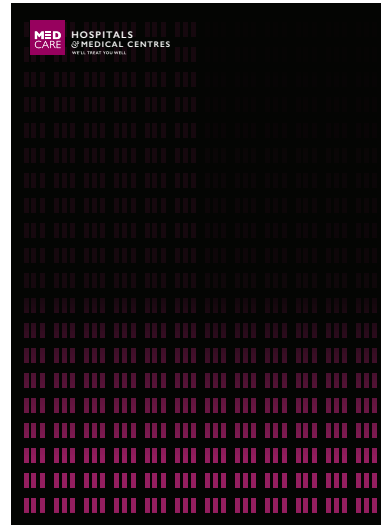

Size :
Leaf - 26 cm
Total width - 54 cm
Paper thickness : 350gsm
finishing : matte

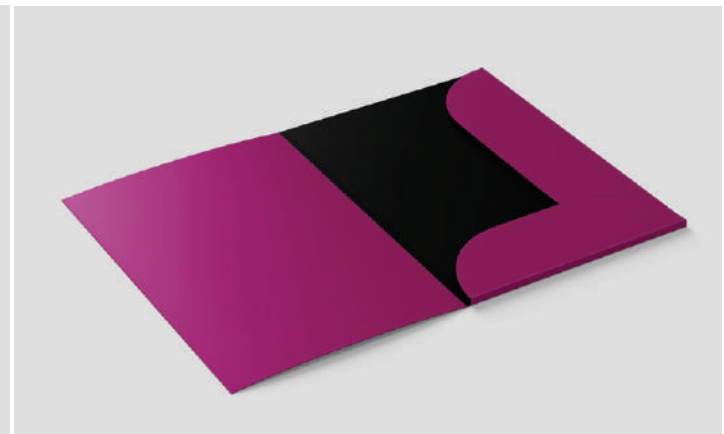
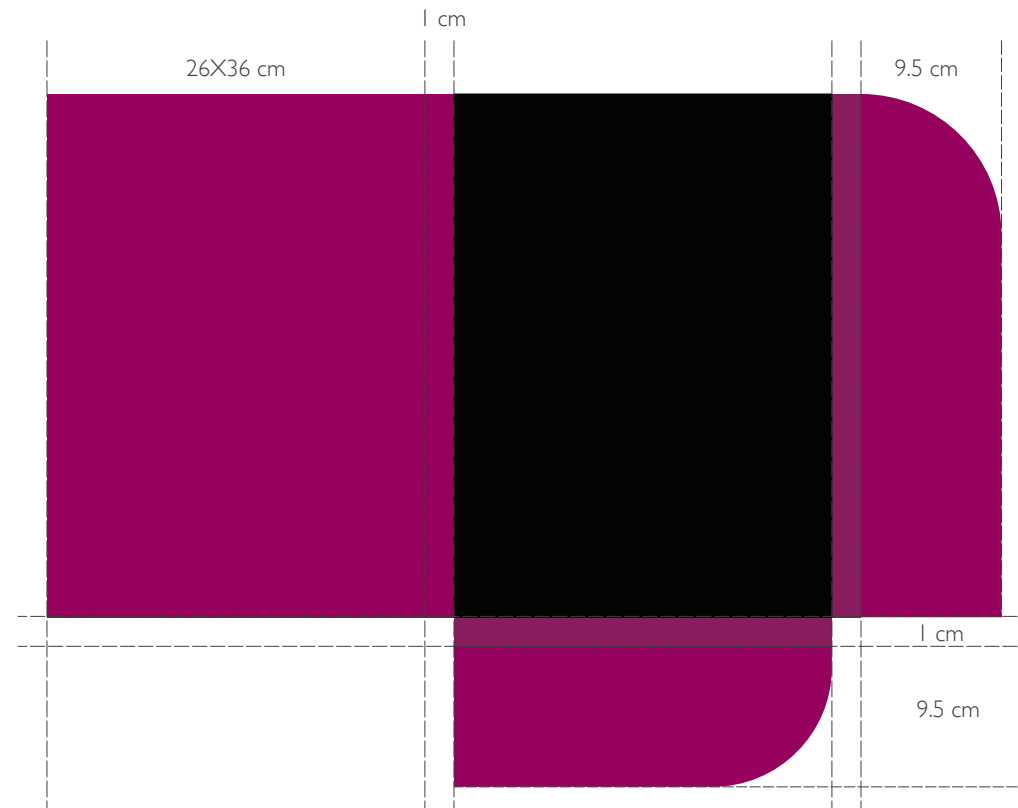

04

Corporate Designs

9. TISSUE BOX

Paper thickness : 350gsm
finishing : matte

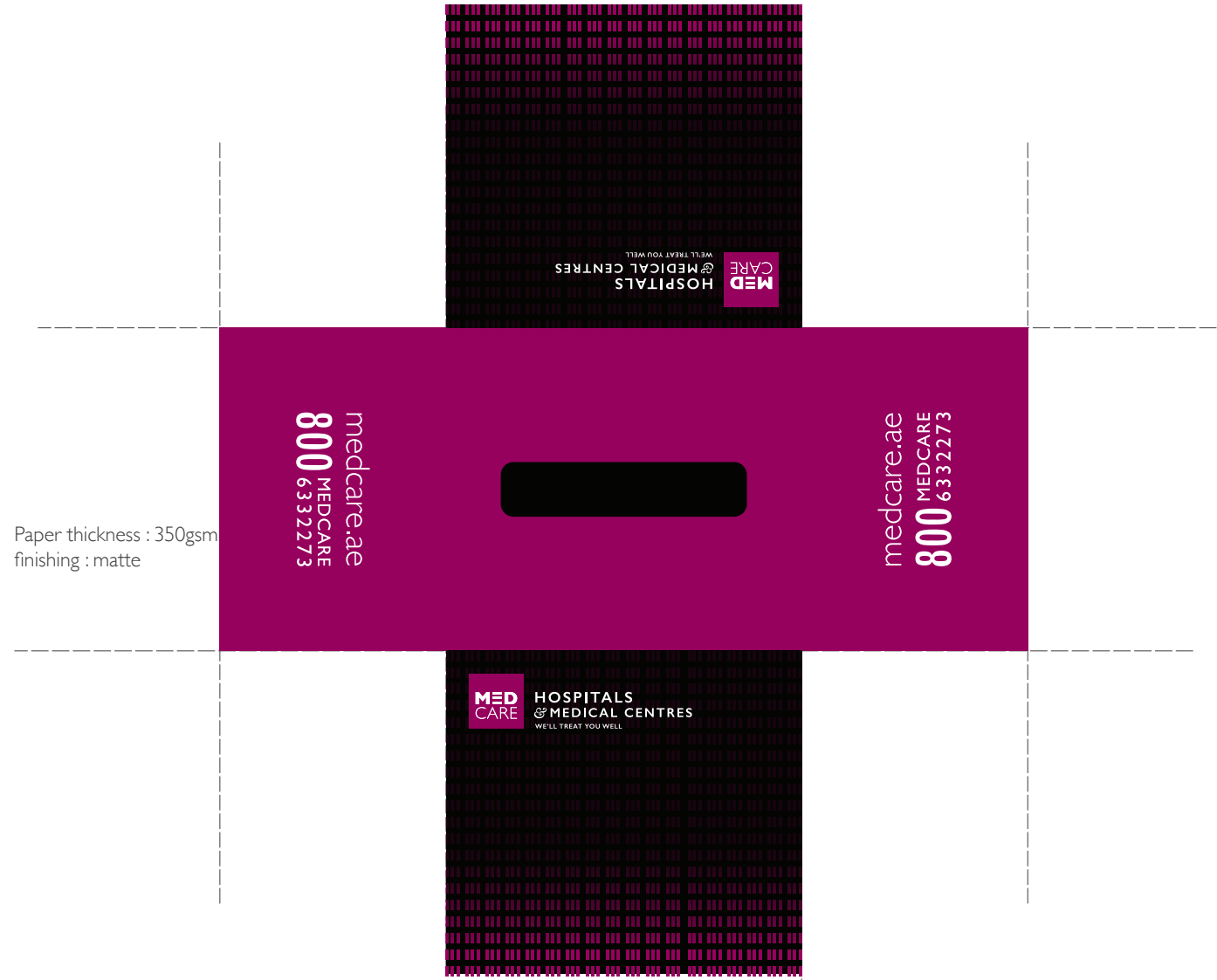

04

Corporate Designs

10. CALENDAR



Size : A5
Paper thickness : 250gsm
finishing : matte

04

Corporate Designs

11. MUG



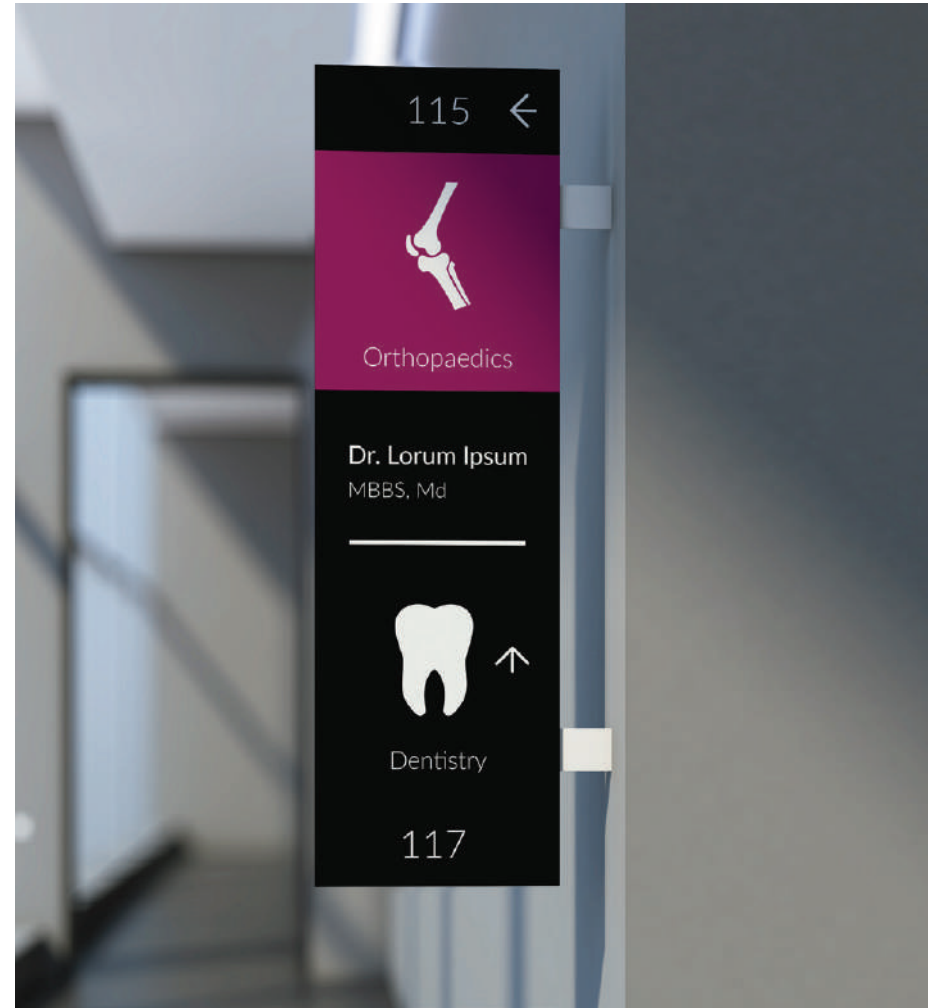
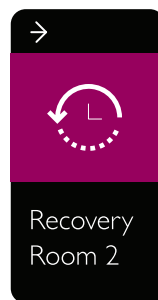
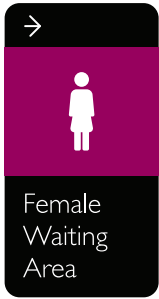

04

Corporate Designs

13. VEHICLE BRANDING

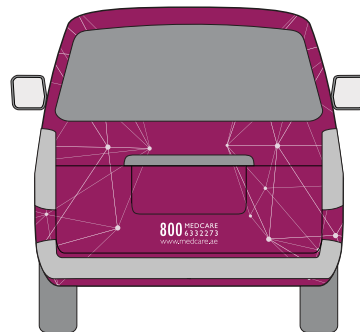

04

Corporate Designs

14. LANYARD

WE'LL TREAT YOU WELL

800 MEDCARE
6332273
www.medicare.gov

**MED
CARE**



04

Corporate Designs

15. DEPARTMENT ICONS



Dentistry



Dermatology
Aesthetics



ENT



Gastroenterology



Surgery



Endocrinology



Family
Medicine



Internal Medicine



Obstetrics &
gynaecology

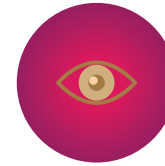

Ophthalmology



Neonatology



Pulmonology



Orthopaedics



Pediatrics



Physiotherapy

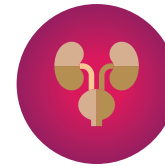

Urology



Cardiology

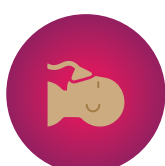

Anesthesia

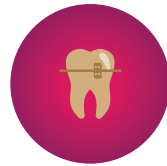

Orthodontal



Radiology



Family
Medicine



Obstetrics &
Gynecology



Neurology



Dermatology



Rheumatology



Diet & Nutrition



Emergency



Oncology



Nephrology



04

Corporate Designs

16. EMAIL SIGNATURE



FIRST SECOND Designation

📍 **Medcare Support Office**
621 Jumeirah Beach Road, P.O. Box: 215565
Dubai, United Arab Emirates

📞 052561527 📠 34561527

✉️ name@medcarehospital.com

🌐 www.medcare.ae



Hi, I'm Mira & he is Leo. We are the new Medcare Health Assistants. Click here to chat with us

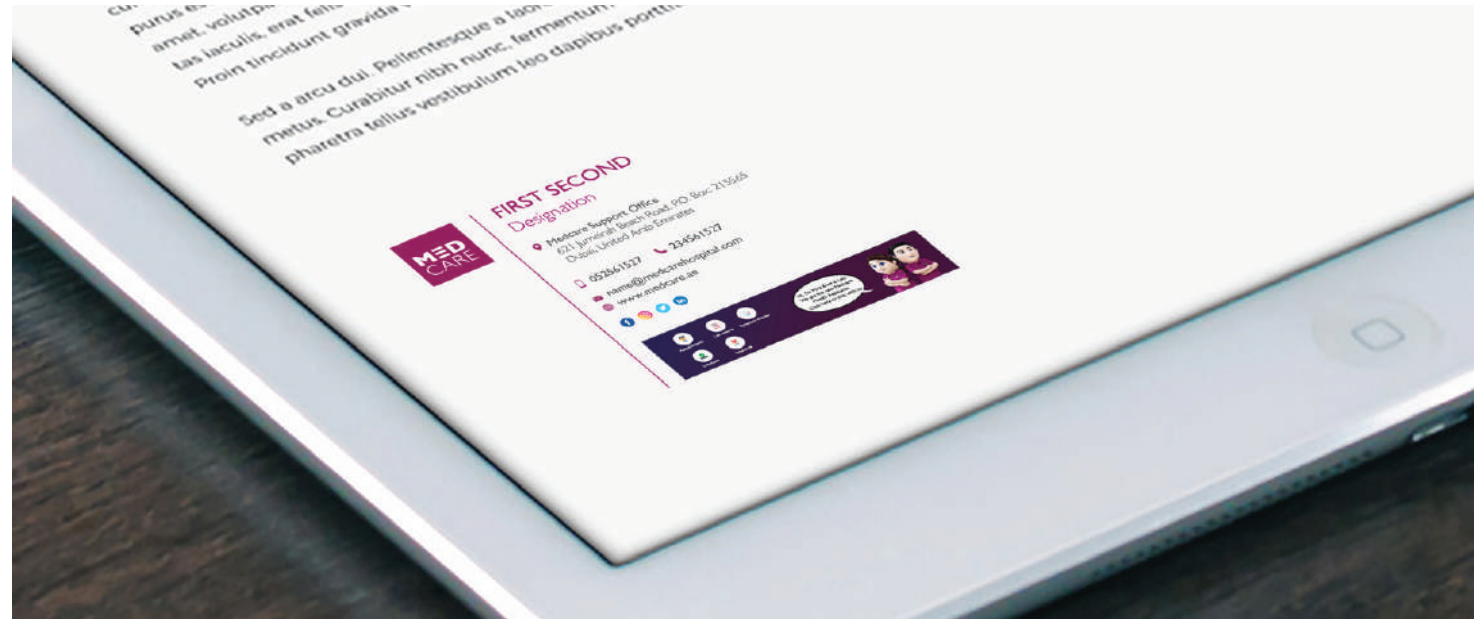

04

Corporate Designs

17. OUTDOOR ADVERTISING

Design Structure



Content section should not exceed 40 %



04

Corporate Designs

18. OUTDOOR ADVERTISING

80%

20%

Image

Caption



04

Corporate Designs

19. GLASS STICKER



Logo & contact



Logo & contact

Caption

Image

Other Information

text minimum size
46pt (English)
42p2 (Arabic)



Dentistry



Dermatology
Aesthetics



ENT



Gastroenterology



Surgery

Departments logos can also be used.
This depends on the dimension, size and visibility

04

Corporate Designs

20. EXHIBITION STAND





HOSPITALS
& MEDICAL CENTRES
WE'LL TREAT YOU WELL

Medcare Social Media Guidelines

**Social Media Guidelines:
Where Our Brand Goes
Viral, Not the Flu!**



Facebook

1080x1080 pixel

Logo position

MED
CARE

Text position &
layout

Lorem ipsum dolor sit
amet ullamcorper suscip

Text size:
58 - 70 pt

consectetur adipiscing elit,
nonummy nibh euism

Book your session

800 MEDCARE
6332273

medcare.ae

CTA bar

Facebook/Social media

Examples

Post

1080x1080 pixel



Events

1080x1080 pixel



Story/reel

1080x1920 pixel



Facebook/Social media

Examples



MED CARE



**Don't Fear
The Smear!**

Consultation +
HPV test + Papsmear

AED 475

GET TESTED

800 MEDCARE
6332273

medcare.ae



MED CARE

**Expert urology care
at your fingertips**

take control of your urinary health

Book Now

800 MEDCARE
6332273

medcare.ae

Doctor announcement



WELCOMING

DR. BASMA BASHIR
Consultant Family Medicine

**Medcare Medical Centre,
Meadows**

800 MEDCARE
6332273

medcare.ae



Live Session



LIVE



**Managing
diabetes**

Dr. Abdul jabbar
Consultant internal
medicine and endocrinologist

 **June 7, 2022, 10:40 AM**

800 MEDCARE
6332273

medcare.ae



Dont's

Examples of artwork overwhelmed by extensive text that detracts from its visual impact.



Thank You